



# Understanding U.S. Patent Reform and What It Means to Your Business and Practice

11 October 2011

Ordine and AICIPI - Milan

Eric P. Raciti, LL.M • Anthony C. Tridico, Ph.D.

FINNEGAN

# Disclaimer

---

These materials are public information and have been prepared solely for educational and entertainment purposes to contribute to the understanding of U.S. intellectual property law. These materials reflect only the personal views of the authors and are not a source of legal advice. It is understood that each case is fact specific, and that the appropriate solution in any case will vary. Therefore, these materials may or may not be relevant to any particular situation. Thus, the authors and Finnegan, Henderson, Farabow, Garrett & Dunner, LLP cannot be bound either philosophically or as representatives of their various present and future clients to the comments expressed in these materials. The presentation of these materials does not establish any form of attorney-client relationship with the authors or Finnegan, Henderson, Farabow, Garrett & Dunner, LLP. While every attempt was made to ensure that these materials are accurate, errors or omissions may be contained therein, for which any liability is disclaimed.

- Passage of U.S. Patent Reform Legislation
- Creation of First-Inventor-to-File System and Corollary Derivation proceedings
- Definition of Prior Art and Its Impact
- Mechanisms to Challenge U.S. Patents and Patent Applications
- Supplemental Examination and Impact on Inequitable Conduct
- Other Changes – prior user rights, best mode, prioritized examination, false marking, etc.

# Summary of Effective Dates

---

- Effective date of provisions is one year from enactment unless otherwise provided (**September 16, 2011**)
- First-to-File: **March 16, 2013**
- Pre-issuance Submissions: **September 16, 2012**
- PGR and IPR: **September 16, 2012**, with **graduated implementation** first four years
- Supplemental Examination: **September 16, 2012**
- Reissue Amendment: **September 16, 2012**
- Higher threshold to enter Inter Partes Reexam: **immediately** upon enactment

# Summary of Effective Dates

---

- Best Mode: **immediately** upon enactment
- Tax Strategy Inventions: **immediately** upon enactment
- Prioritized Examination: **ten days** after enactment
- Micro Entity: **immediately** upon enactment
- False Marking: **immediately** upon enactment
- Statutory Invention Registration: **March 16, 2013**
- PTO Fee Setting Authority: **immediately** upon enactment

# Still to Come: USPTO Rulemaking

## Federal Rulemaking Process

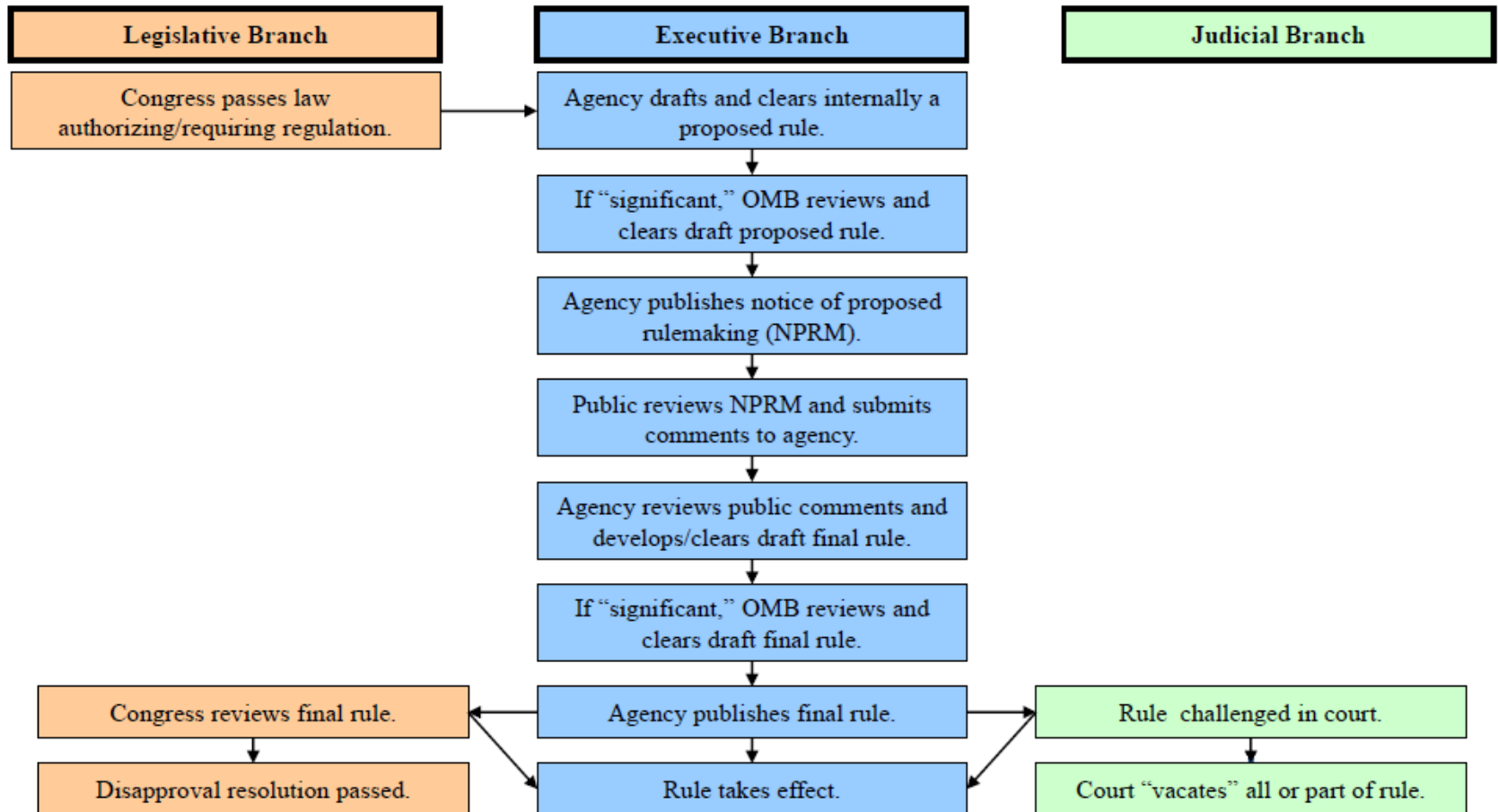

---

# **Creation of a First-Inventor-To-File System (FITF)**

# First to Invent (FTI) → First Inventor to File (FITF)

---

- AIA replaces long cherished *first-to-invent* system with a *first-inventor-to-file* (“FITF”) system
  - Only partial harmonization
- Achieved by rewriting of 35 U.S.C. § 102
  - Replaces current §102 (a)-(g) with new §102 (a)-(d)
  - Absolute novelty requirement *almost* imposed, but limited inventor grace period
  - Redefines what is prior art (increases quantity available)
  - Defines the effective date of prior art patents and published applications
  - Clarifies conditions for protected joint research under common ownership



# “First to Invent” (The Current Law)

---

§102(a): prior art of others

§102 (b): statutory bar,  
prior art of anyone

§102(e): prior patents  
& published appln's of  
others



§102(f): derivation

§102(g): first to  
invent

**35 U.S.C. § 102**

# First to Invent Novelty (FTI)

---

- Prior to Applicant's DATE OF INVENTION
  - 102(a)
  - 102(e)
  - 102(g) – basis for first to invent system
- More than 1 Year BEFORE U.S. FILING DATE
  - 102(b)
  - 102(d)

# 35 U.S.C. 102(a) – Overview (FTI)

---

- In the U.S. ... the invention was

- KNOWN BY OTHERS
- USED BY OTHERS



- Anywhere in the world ... the invention was

- PATENTED
- PRINTED PUBLICATION

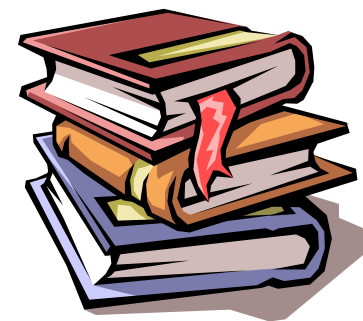

# Time Line Example: 35 U.S.C. 102(a) (FTI)

---

- Event: Publications anywhere in the world, public knowledge or public use in the U.S. of another
- Before date of invention: can “swear behind”
- Policy:
  - the inventor must “invent” prior to public knowledge
  - No patent for known invention

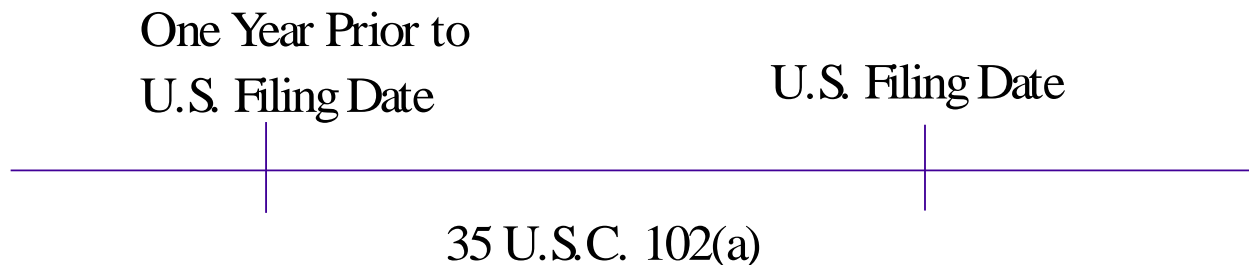

# Section 102(a): Scope of Prior Art

---

- Public use
  - Not secret; not internal
  - Complete invention (not experimental)
- Public knowledge
  - Access available to those working in the relevant art
  - Non-disclosure agreement in place?
- Printed publication
  - “Public accessibility” test
  - Not just “printed” – microfilm, computer storage, internet
  - Effective date when public had access
- Enabling disclosure
  - Prior art reference must sufficiently describe the invention to put the public in possession of the invention

# Time Line Example: 35 U.S.C. § 102(b) (FTI)

---

- Event: Offer for sale (US), public use (US) or publication (anywhere) more than one year before the U.S. filing date
- Statutory bar: CANNOT “swear behind”
- Policy: an inventor who does not diligently file risks losing the ability to patent

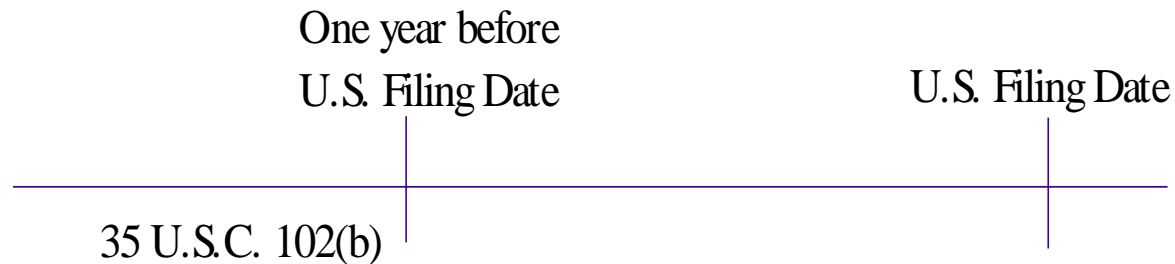

# How the U.S. Grace Period Works

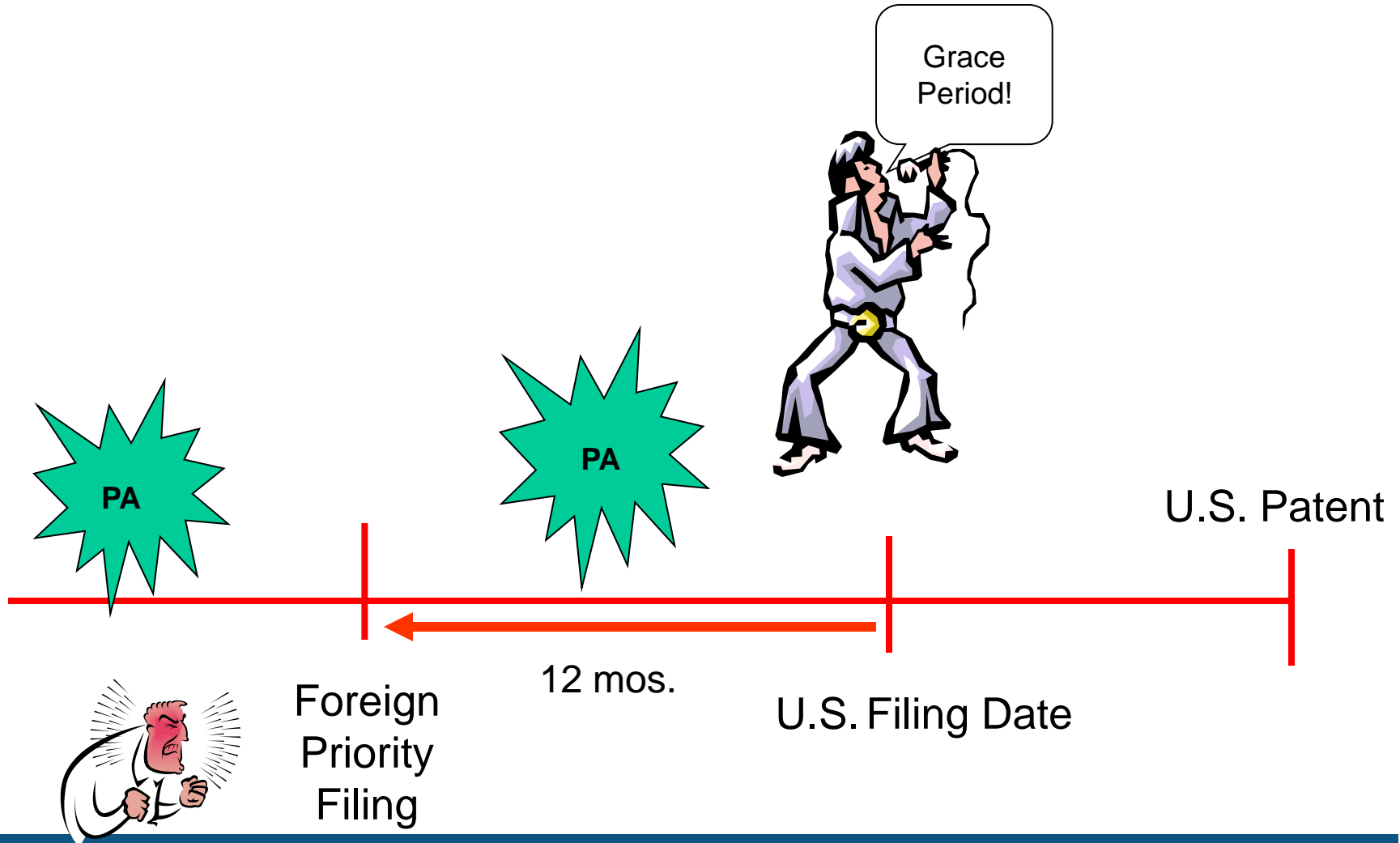

# On-Sale Bar Standard

---

- ***Pfaff v. Wells Electronics***, 119 S.Ct. 304 (1998)
  - Inventor developed new chip socket
    - engineering drawings, but no prototype
    - TI made written purchase order
  - **TEST:** A patent is invalid if more than one year before its U.S. filing date:
    - There was a commercial offer for sale of invention in U.S.
      - not experimental use
    - ...AND the invention is ready for patenting
      - actual reduction to practice; or
      - information to write application (enabling)



# Section 102(e) (FTI)

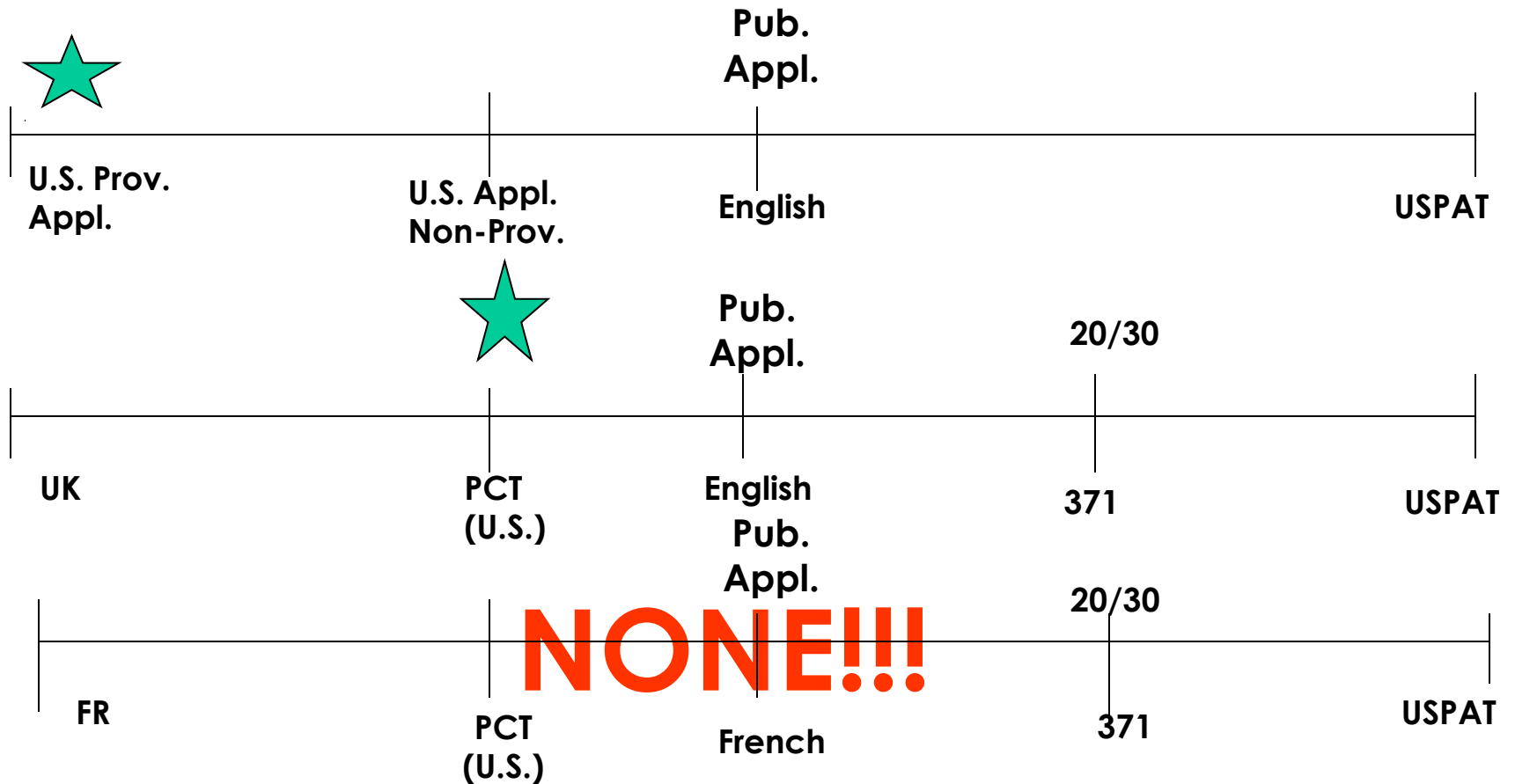

**NOTE:** All appl. filed on or after 29 Nov. 2000

---

# **New Definition of Prior Art**

## **(FITF)**

# Effective Date

**18 months after enactment:**  
any application for patent and  
to any patent issuing thereon,  
**that contains or contained at**  
**any time – a claim** to a  
claimed invention with an  
effective filing date ...that is on  
or after the effective date...

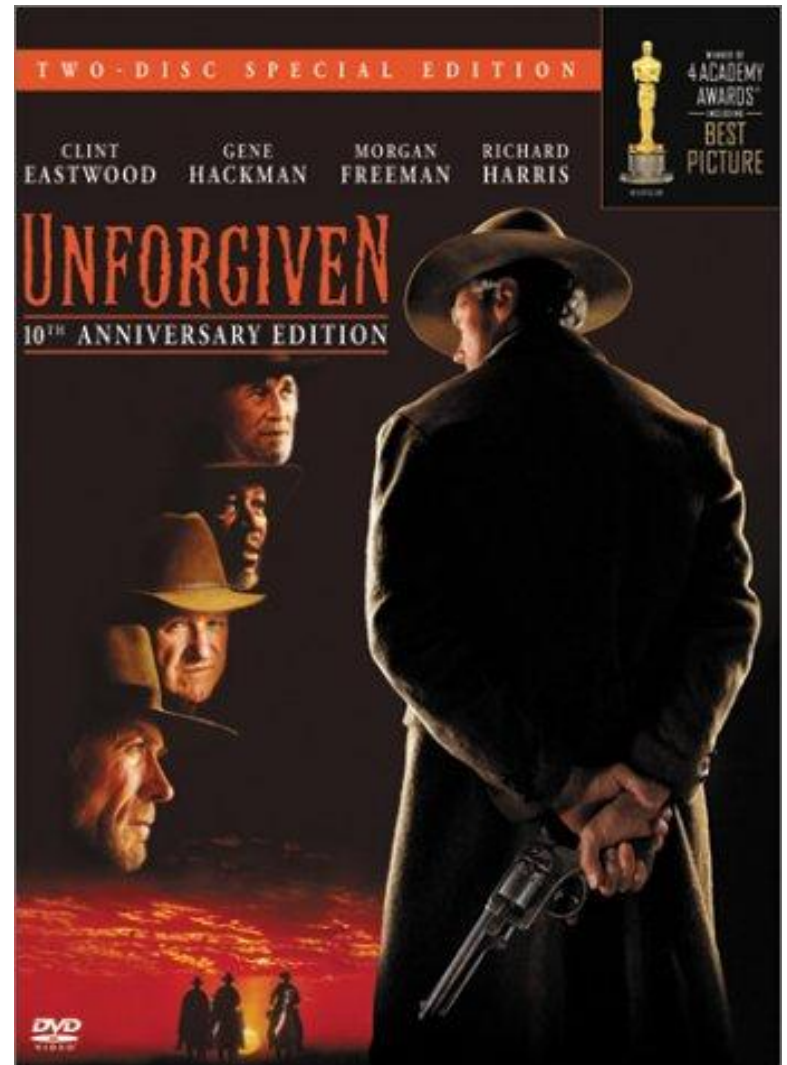

# Straddling the Effective Date: Double Trouble

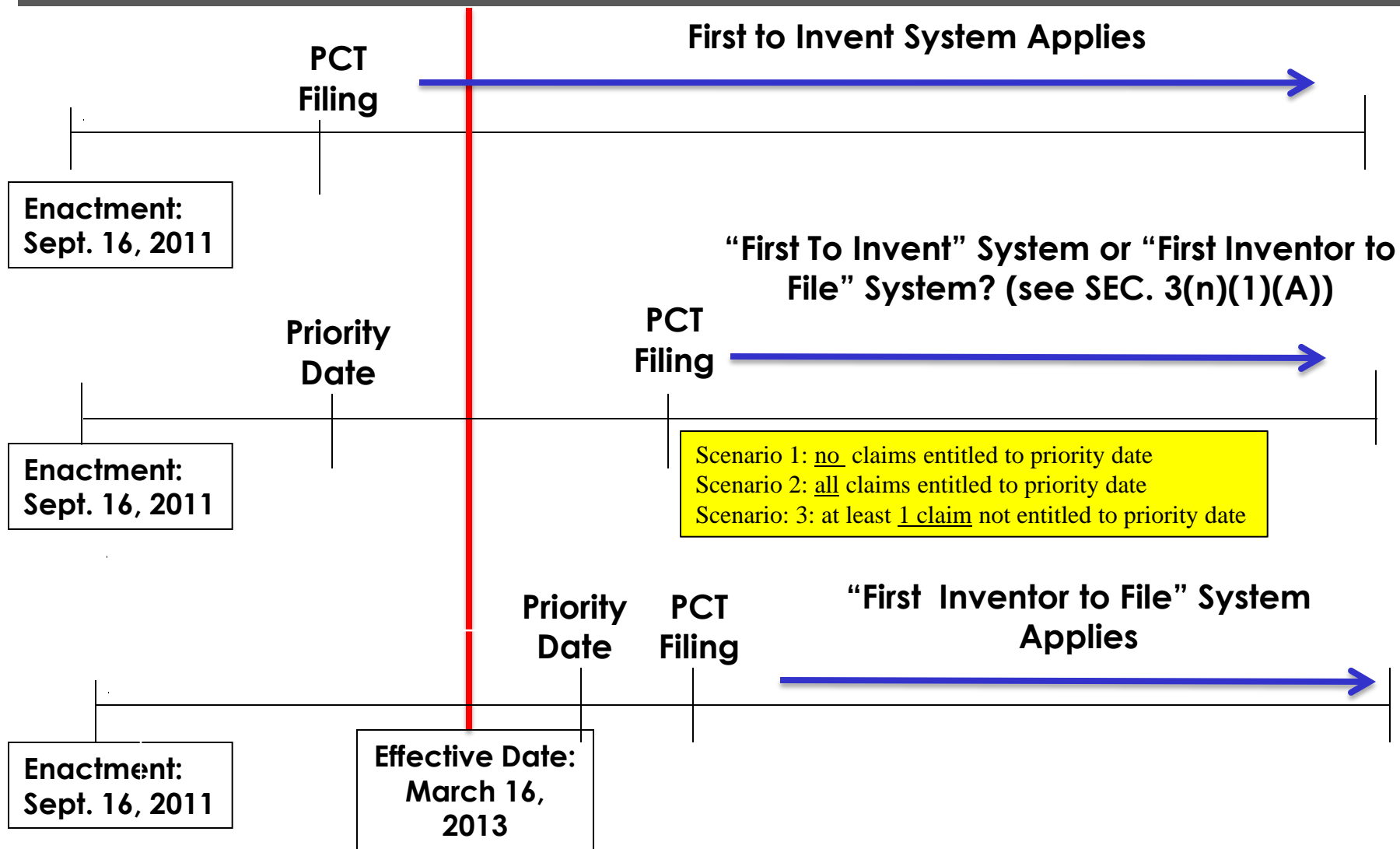

# One Claim is all it takes

File the PCT or a second priority document  
PRIOR to Effective date to keep under First to Invent

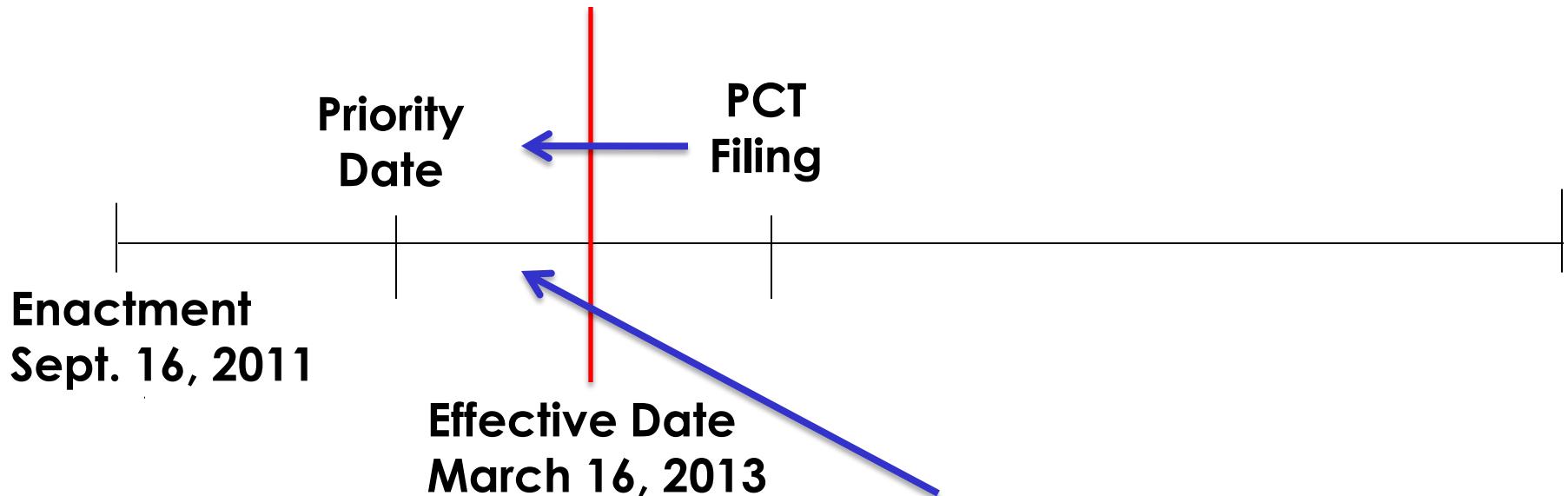

Present new patentable  
subject matter and new  
applications prior to the  
effective date

# Evolution of New Definitions of Prior Art

**102(a)(1) – Defines prior art (derived from current 102(a) & (b))**

**102(b)(1) – Identifies exceptions to 102(a)(1) prior art**

**102(a)(2) – Defines prior art (derived from current 102(e))**

**102(b)(2) – Identifies exceptions to 102(a)(2) prior art**

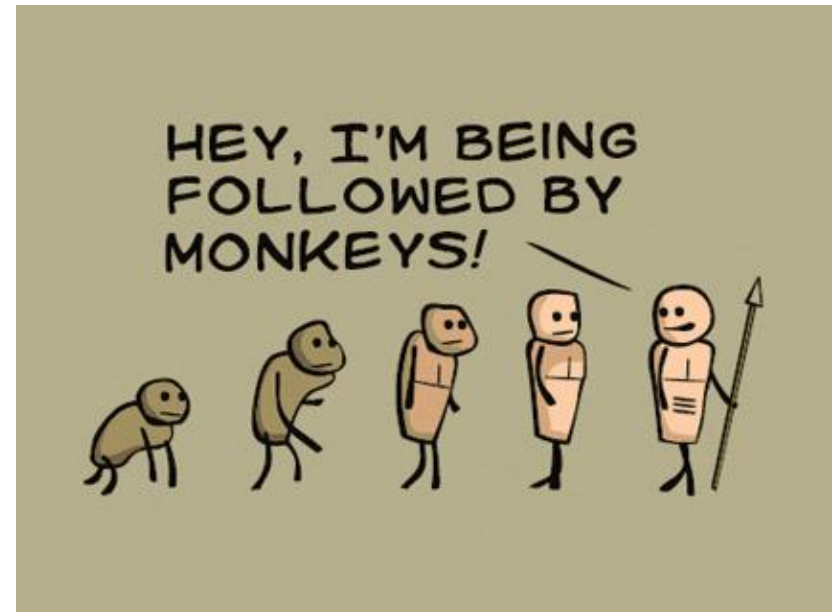

# New 35 U.S.C. § 102(a)

---

## §102 Conditions for patentability

### (a) NOVELTY; PRIOR ART.

A person shall be entitled to a patent **unless**—

- (1) the claimed invention was \*patented, \*described in a printed publication, or \*in public use, \*on sale, or \*otherwise available to the public *before the effective filing date of the claimed invention*; or
- (2) the claimed invention was \*described in a patent issued under section 151, \*or in an application for patent published or deemed published under section 122(b), in which the patent or application, as the case may be, names another inventor and was *effectively filed before the effective filing date of the claimed invention*.

# Definition of Prior Art: Public Information (102(a)(1))

---

- “[P]atented” or “[D]escribed in a printed publication”
- “[I]n public use”
- “[O]n sale”
  - Must the sale/offer under new law be public?
    - Note no “public” limitation is linked to “on sale”, but is linked to “in public use”.
  - Currently “on sale”, without “public” limitation has been interpreted to include commercial offers for sale, whether public or not.
- “[O]therwise available to the public”
- No geographical limitations on prior art acts (OUS acts = US acts)



# First-to-Invent vs. First-Inventor-to-File

First-to-Invent: X Can Win

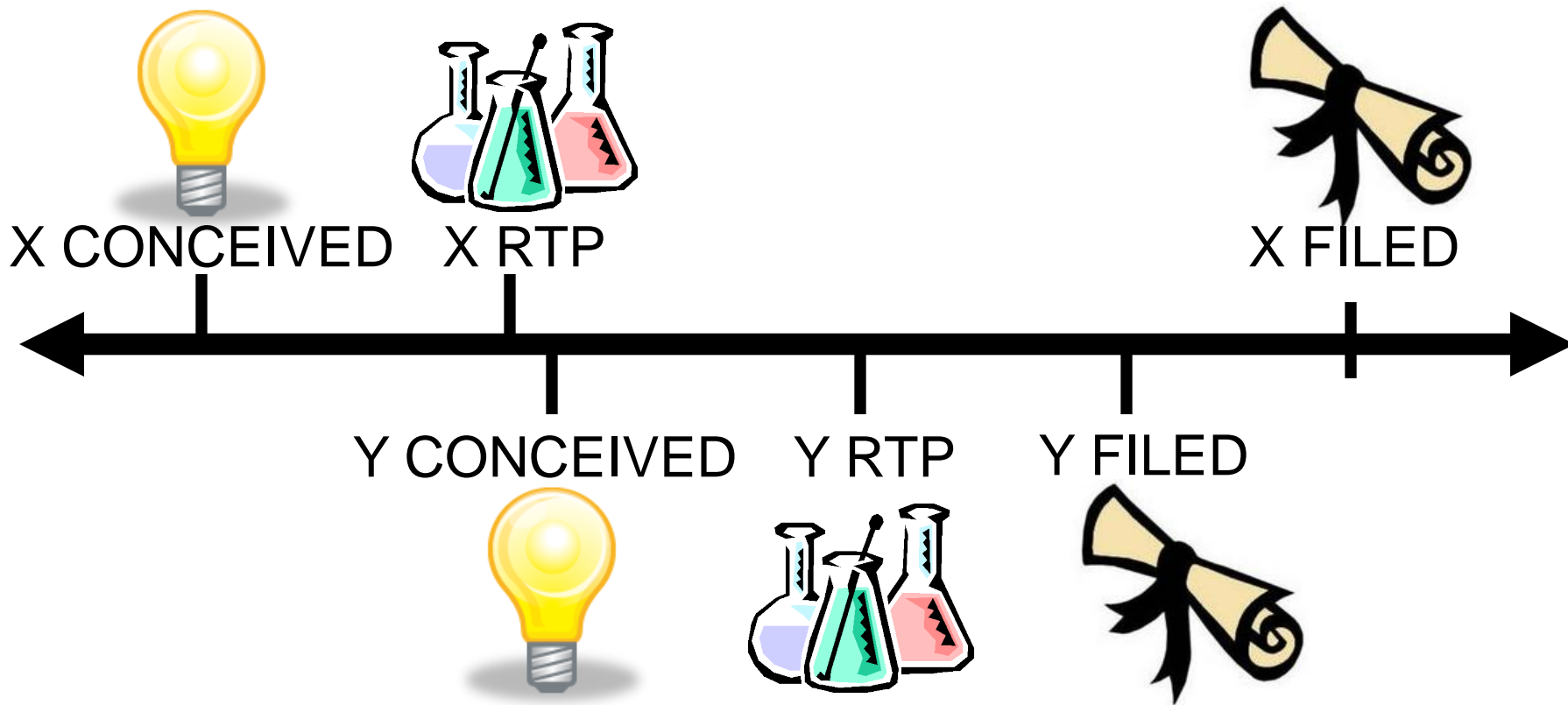

First-Inventor-to-File: Y Wins

# Definition of Prior Art: Scenario 2

€

X SOLD IN EUROPE  
(Confidential???)

Y FILED



- FTI: Sale of X Not Prior Art to Y because not in US
- FITF: Sale of X Is Prior Art to Y
  - anytime if sale is by 3<sup>rd</sup> party
  - If from inventor's work – one year grace period.

# Definition of Prior Art: 102(a)(2)

---

- Covers Earlier-Filed but Later-Published Patent Documents
- Like current section 102(e)
  - Following publication, the disclosure has retroactive availability as prior art as of effective filing date
  - Available as prior art for **novelty** and **obviousness** purposes
- “[D]escribed in a patent ... or in an application (US or PCT designating US) ...”
  - names another inventor, and
  - was effectively filed before the effective filing date of the claimed invention”

# Definition of Prior Art: Scenario 1

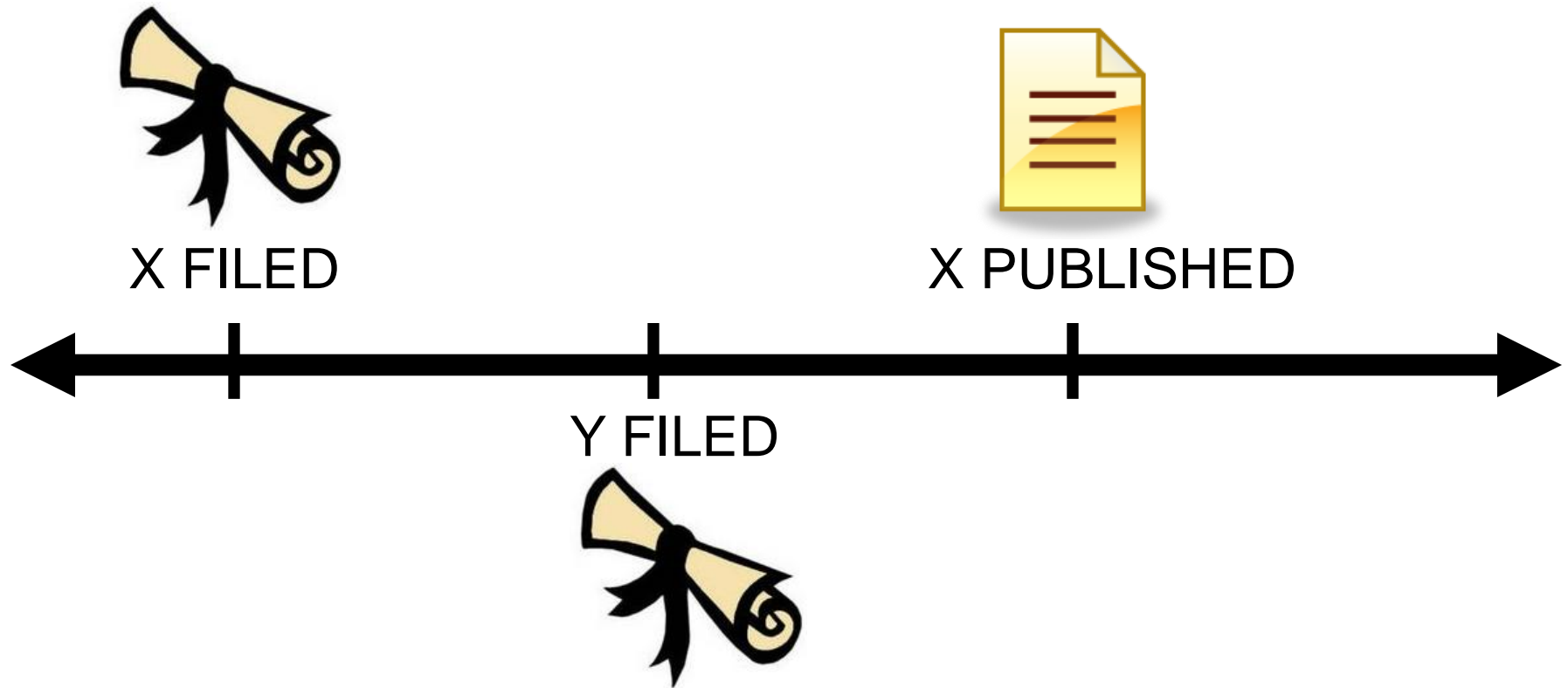

- FTI: Y Could Antedate X with evidence of earlier invention
- FITF: Since X filed first, X is Prior Art to Y  
**(for 102 and 103 purposes)**

# Effective Prior Art Date – New §102(d)

---

- For purposes of determining whether a patent/application is prior art to a claimed invention, such patent/application will be deemed to have been effectively filed as of:
  - The actual filing date of the patent or the application for patent containing the relevant subject matter; or
  - The filing date of the earliest application for which the patent or application containing the relevant subject matter is entitled to a right of priority (§§ 119, 365) ...or benefit (§§ 120, 121 or 365(c))...
- No requirement for U.S. filing date
- Foreign priority date will satisfy



# Hilmer Doctrine Abolished by New §102(d)

---

- New §102(d) eliminates need for foreign applicants to file provisional applications by establishing that an application is “effectively filed” on the date an application was filed under §119 or § 365.
- Hilmer Doctrine evidenced bias of U.S. law against inventions originating outside the U.S.
  - Based on two U.S. litigations (Hilmer I and II) that held that the foreign right of priority of a U.S. patent does not provide a prior art effect under 102(e) as of that foreign priority date, nor does inventive work outside the U.S. have a prior art effect under 102(g). Rather, needed a U.S. filing date to have a prior art effect.
  - Created “shield vs. sword” distinction
- Foreign applicant needed to file in the U.S. to get a 102(e) or 102(g) prior art effect date.
- Current foreign applicant practice: file US provisional at the same time as foreign priority application to get earliest 102(e) date.

# Impact of New 102(d) – Prior Art Date

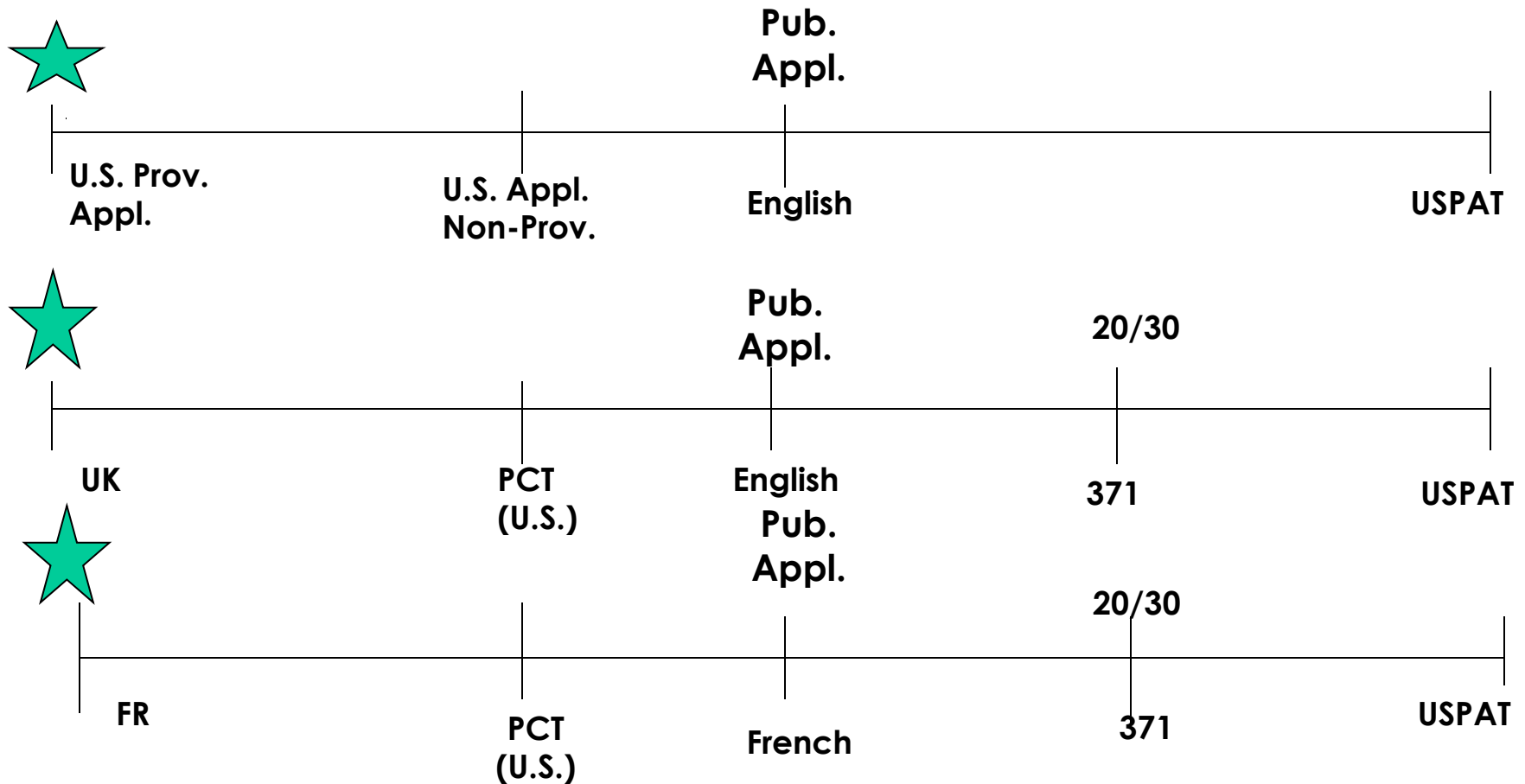

**\*\* NO Geographical or Language Distinction**

# New 35 U.S.C. § 102(b)

- These exceptions define what is not prior art under §§ 102(a)(1) and (a)(2), respectively:
- §102 (b) EXCEPTIONS.
  - (1) Disclosures made 1 year or less before the effective filing date of the claimed invention are not prior art under (a)(1) if:
    - (A) made by an inventor or by another who obtained the subject matter directly or indirectly from an inventor, or
    - (B) if the subject matter had been previously publicly disclosed by an inventor or one who obtained it directly or indirectly from an inventor;
  - (2) Disclosures appearing in applications and patents are not prior art under (a)(2) if:
    - (A) obtained directly/indirectly from an inventor;
    - (B) the subject matter was publicly disclosed before filing by an inventor or one who obtained it directly or indirectly from an inventor; or
    - (C) the subject matter disclosed and the claimed invention, not later than the effective filing date of the claimed invention, were owned by the same person or subject to an obligation of assignment to the same person.



# Definition of Prior Art: Exceptions

---

## Inventor's Own Work

- Limited/Personal “Grace Period”  
(Ex: Publication by or obtained from any inventor NO requirement for the same inventive entity)
- During year before **effective** filing date
- Disclosure made by an inventor or by another who obtained it from any inventor, or
- Disclosure by another but subject matter previously disclosed by an inventor or another who obtained it from any inventor

# Definition of Prior Art: Exceptions

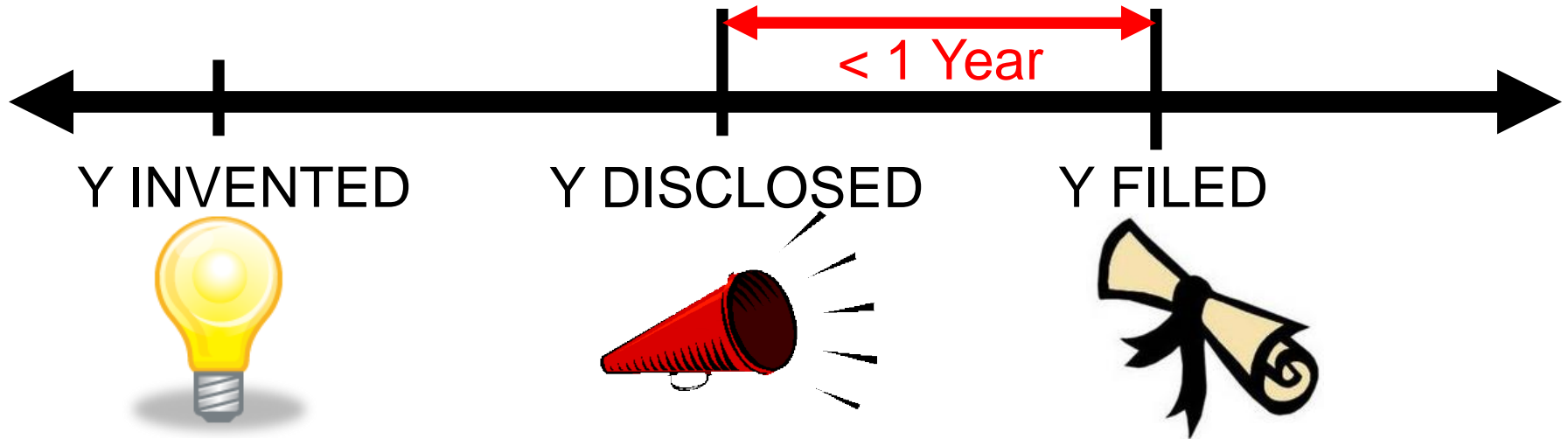

- New Law: Y's Disclosure Not Prior Art

# How the NEW U.S. Grace Period Will Work (102 (b)(1)(A))

Disclosure “by or obtained from” an Inventor

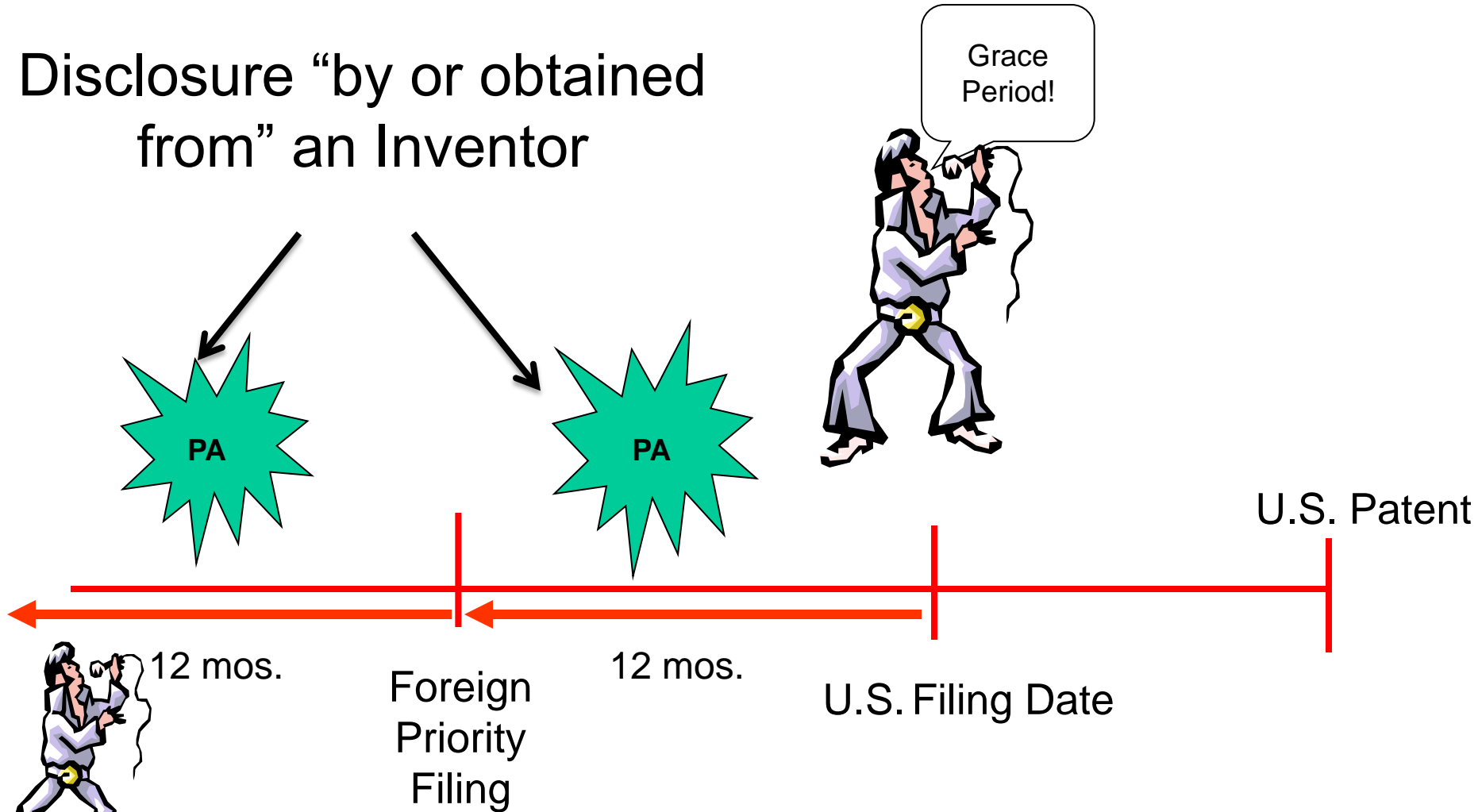

# How the NEW U.S. Grace Period Will Work (102 (b)(1)(B))

Disclosure “by or obtained from” an Inventor

Disclosure by ANYONE

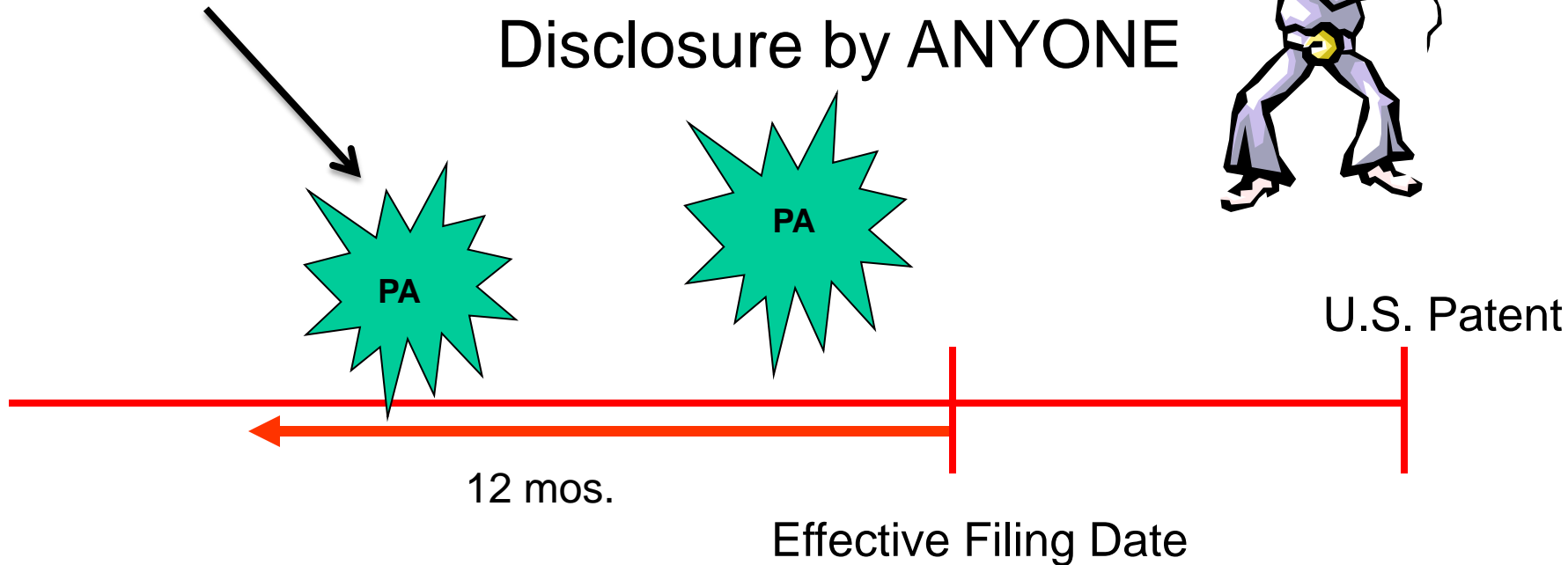
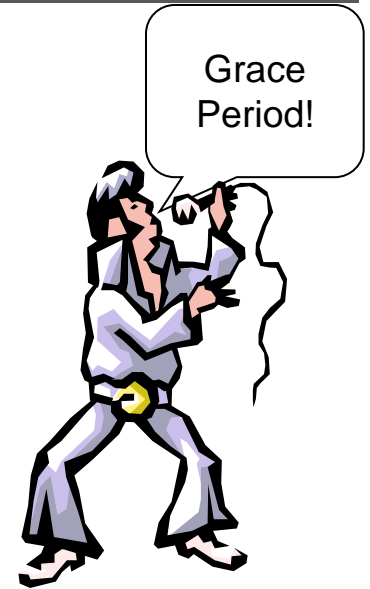

# Definition of Prior Art: Exceptions (102 (b)(2)(A)-(C))

---

## Earlier Filed – Later Published Patent Document \ Disclosures (similar to current 102(e))

- Not Prior Art if
  - Disclosure obtained from an inventor
  - Disclosure made public by inventor before effective filing date of reference, or
  - Common ownership of disclosure and claimed invention before effective filing date of claimed invention
  - Includes collaborations under joint research agreements if:
    - (1) joint research agreement in force by effective filing date;
    - (2) claimed invention results from the joint research efforts; and
    - (3) the application/patent discloses the parties to the research agreement.

# U.S. Interference vs. Derivation Proceedings

## ■ Interference Winner

- First to Invent gets patent
  - Even if second to file
- Consider inventive acts:
  - Compare conception and reduction to practice dates
  - Possible diligence consideration



## ■ Derivation Winner

- First to conceive and communicate to another
  - Consider conception acts
  - Evaluate communication to another
  - Unauthorized filing of application

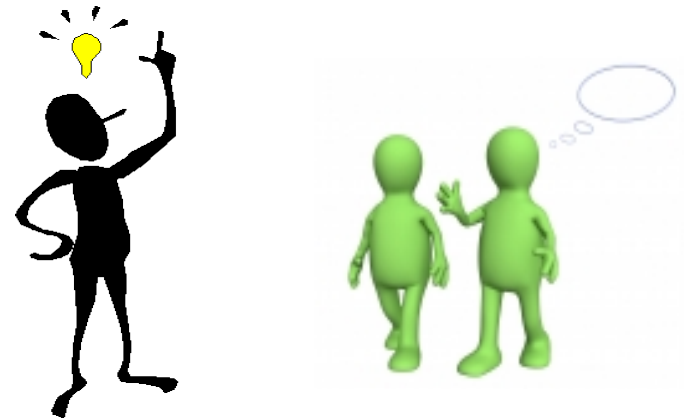

# What Happens to U.S. Interferences?

---

- Eliminated; but possible if application/patent has:
  - Claims having a priority date earlier than 18 months after enactment of new law; or
  - A priority reference to an earlier-filed patent or application that contained such a claim
- Director to determine fate of interferences commenced up to 1 year after enactment of new law
  - May be continued
  - May be dismissed in favor of post-grant review
  - May not be declared



# **Mechanisms to Challenge Patents & Patent Applications**



# Mechanisms to Challenge

- Pre-issuance Submission by 3<sup>rd</sup> Parties - improved
- Post-Grant Review - new
- Inter Partes Review, and how it differs from Inter Partes Reexam

“This day we fight!”



# Third-Party Challenge

<b>Current Regime</b>	<b>New Regime</b>
Pre-issuance 3 <sup>rd</sup> Party Submissions (limited to citation of publications)	Pre-issuance 3 <sup>rd</sup> Party Submissions (can provide details)
Ex Parte Reexam (post-grant)	Ex Parte Reexam (post-grant)
	Post-Grant Review (within 9 months of grant)
Inter Partes Reexam (post-grant)	Inter Partes Review (after 9 months of grant, term. of PGR or within 1 year of being sued)

# Third-Party Challenge

---

- New legislation creates earlier opportunities to challenge competitor applications/patents
  - Recognition that high-quality patents promote innovation and economic growth
  - Low-quality patents hinder development and investment
- New and revised procedures that open “windows” of opportunity to present challenges
- If used effectively, can more quickly clear a path for new technologies and products, less expensively

# Challenges to Competitors

---

- Consider the following in choosing a mechanism:

- Windows of time
- Threshold for proceeding
- Grounds for challenge
- Limitations on evidence/arguments
- Anonymity
- Estoppel effect
- Oral hearing/appeal availability
- Decision maker desired
- Speed
- Discovery opportunities

\*Broadest reasonable interpretation versus judicial claim construction

# Challenges to Competitors

---

- Search early, search often
  - Not just at milestones related to development of your project
  - Searching on a more regular basis to identify competitors' patents/applications during “windows” of time prescribed in legislation



# PREISSUANCE SUBMISSIONS

# Preissuance Submissions by 3<sup>rd</sup> Parties

---

- Offers substantially more opportunities than current regime, which specifically prohibits explanation of the submission or any other information and limits submission to 10 documents
- New procedure requires concise description of the relevance of each document
- No limit to number of documents
- Effective Date: One year after enactment

# Preissuance Submissions by 3<sup>rd</sup> Parties

---

- Identify problematic applications during their pendency and submit prior art during examination
  - Limited period of time
    - Unless case has been allowed
    - The later of
      - at least 6 months from publication
      - or
      - until 1<sup>st</sup> rejection



# Preissuance Submissions by 3<sup>rd</sup> Parties

---

- Advantages
  - Can significantly impact prosecution
    - Opportunity to present art and arguments when examiner first evaluating claims
  - Can remain anonymous
  - Cost would be low
  - No threshold requirement (e.g., substantial new question (SNQ) of patentability required for current reexams)

# Preissuance Submissions by 3<sup>rd</sup> Parties

---

- Disadvantages
  - Very early window
  - Need to learn about and act on potentially threatening applications shortly after their publication
  - No opportunity to present additional arguments during pendency, no oral hearing, no appeal
  - Puts art before Examiner → presumption of validity over that art

# Third-Party Challenges: Current

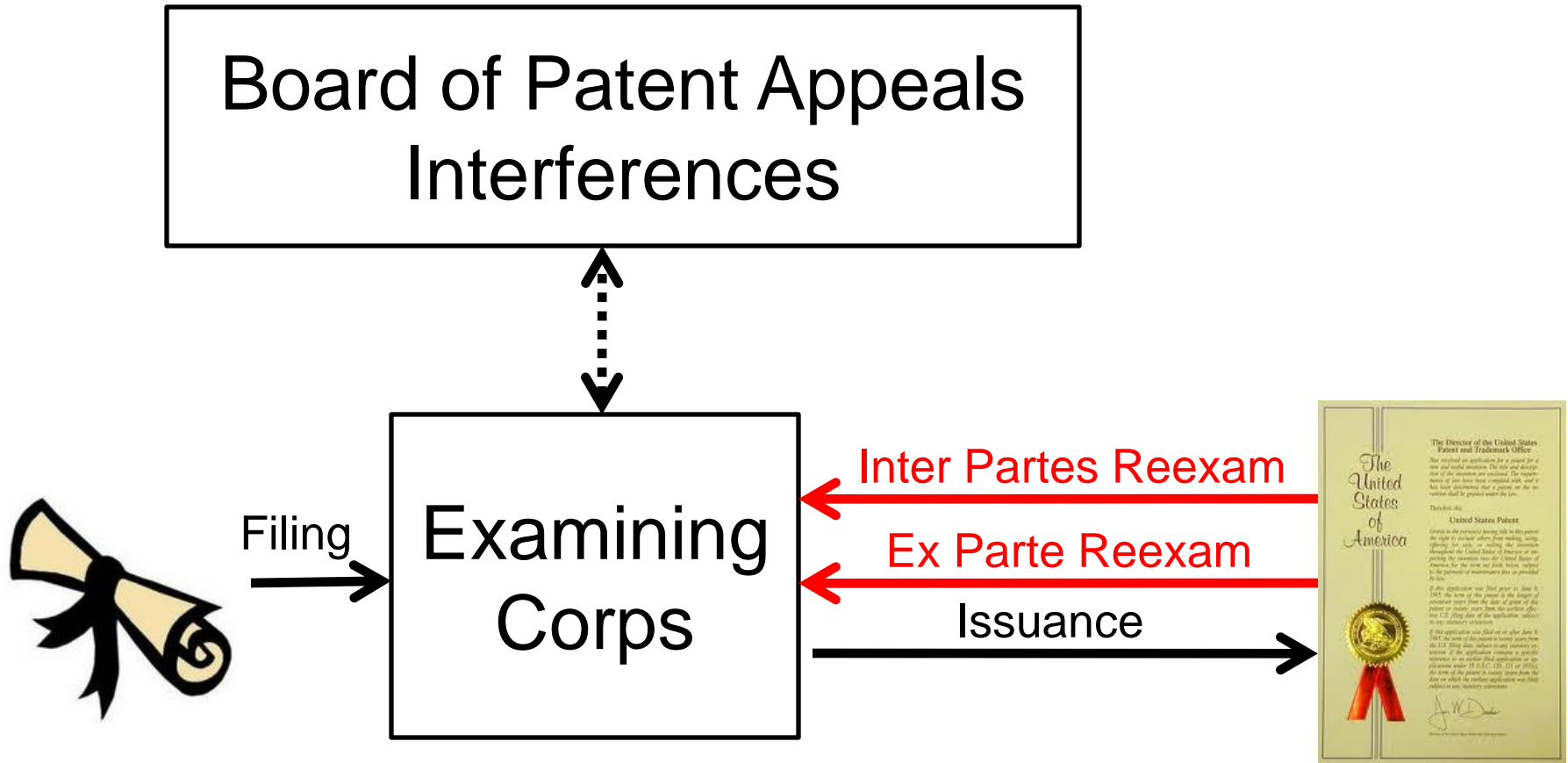

# Third-Party Challenges: New

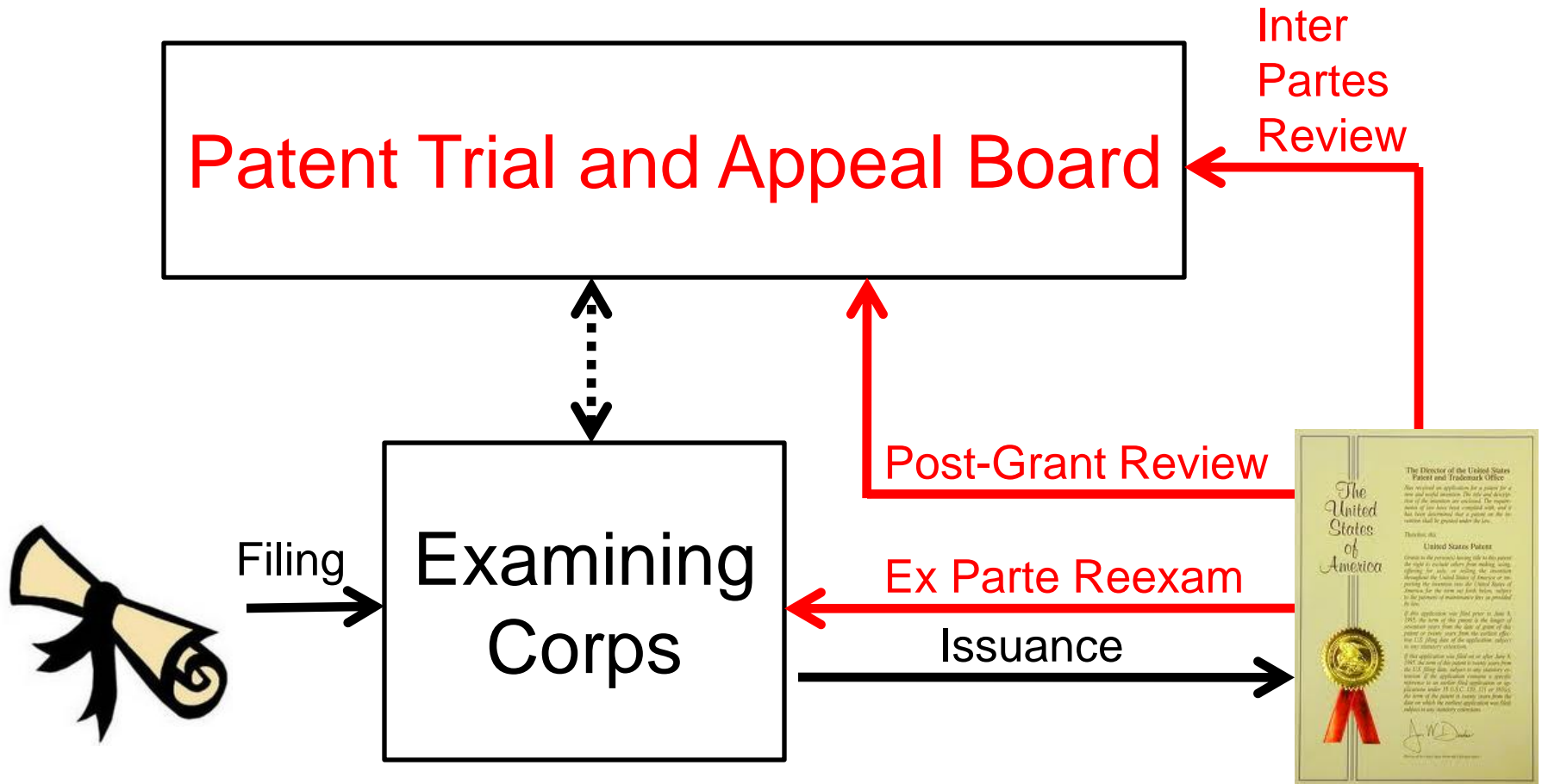



# POST-GRANT REVIEW (PGR)

# Post-Grant Review (PGR) – Introduction

---

- Allows challenge within 9 months of patent grant
- Can be based on **any** ground that could be raised under paragraphs (2) or (3) of 35 U.S.C. § 282
  - Prior art
  - Utility and patent eligibility
  - Enablement, written description, definiteness
- Broader grounds than current reexam procedures or inter partes review
- Burden: Preponderance of the Evidence

# Post-Grant Review (PGR) – Eligible Patents

---

- 1-year after enactment: “Business method” patents issued before, on or after the effective date.
- 1-year after enactment: Pending interferences can be “transferred” to PGR (by the Board).
- 1-year after enactment: Patents in the “first inventor to file system”
  - 18 months after enactment: any application for patent and any patent issuing thereon, that contains or contained at any time – a claim to a claimed invention with an effective filing date after the effective date.
  - Likely minimum 3 years from today!!

# Post-Grant Review (PGR): Requirement

---

- Threshold Requirement:
  - The information presented in the petition, if such information is not rebutted, would demonstrate that it is **more likely than not** that at least one of the claims challenged in the petition is unpatentable; or
  - The petition raises a **novel or unsettled legal question** that is important to other patents or patent applications.



# Post-Grant Review (PGR) – Threshold

---

- Important for anyone seeking to institute post-grant review to understand, and emphasize, the importance of evidence establishing a basis for proceedings, and to prepare the strongest initial petition feasible.
- Decision whether to institute not appealable
- **Come out guns blazing!**



# Post-Grant Review (PGR): Timing

---

- File Petition within 9 months of grant
- Patent Owner may respond (arguing against institution of PGR)
- USPTO must initiate or not within 3 months (decision whether to institute not appealable)
- Final determination within 1 year after initiation

# Post-Grant Review (PGR): Requirements

---

- Requirements:
  - Fee;
  - Real parties in interest;
  - Identification with particularity each claim challenged;  
and
  - The grounds upon which it is challenged, and the evidence supporting the grounds for the challenge to each claim.
    - Include affidavits or declaration of supporting evidence and opinions being relied upon by petitioner

# Post-Grant Review (PGR): Proceeding

---

- Petition must identify real party in interest
- The Patent Trial and Appeal Board will conduct each proceeding
  - May allow for discovery of relevant evidence
    - declarations (direct) and depositions (cross exam)
  - Can provide for Protective Orders
  - Oral hearing

# Post-Grant Review (PGR): Proceeding

---

- Discovery is limited to “evidence directly related to factual assertions advanced by either party in the proceeding.”
- Any additional factual evidence and expert opinions relied on must be submitted through affidavits or declarations
- Similar rule making provided under interferences

# Amendments

---

- There is some freedom of the patentee to amend or provide substitute claims, but the ease in doing so will not be entirely clear until the applicable rules are promulgated
- Section 326 sets forth that the patent owner may file a single motion to amend the patent as a matter of right
  - Cancel any challenged claim (§ 326(d)(1)(A)), or to “propose a reasonable number of substitute claims” (§ 326(d)(1)(B))

# Amendments

---

- Additional motions to amend may be permitted upon the joint request of both the petitioner and patent owner for purposes of furthering settlement, or upon the request of the patent owner for good cause
- What is “good cause” (not in statute)?

# Post-Grant Review (PGR): Proceeding

---

- Final determination will be issued within 1 year after initiation
  - For good cause shown, PTO may extend the 1 year period by no more than 6 months
- Either party may appeal to Federal Circuit
  - If appealed, both parties can participate
  - Decision whether or not to institute post-grant review is not appealable



- The final written decision issued will include a determination of both the patentability of any patent claim challenged by the petitioner and any new claim added under section 326(d)
  - cancel, amend, allow to stand as granted
- Settlement: A PGR will be terminated with respect to any petitioner upon the joint request of the petitioner and the patent owner, unless the Board has already decided the merits of the proceeding. If no petitioner remains in the PGR, the Board may terminate it or issue a final written decision.

# Post-Grant Review (PGR): Multiple PGRs

---

- PTO may merge multiple post-grant review proceedings
  - possible when different arguments
- PTO may reject petition because the same or substantially the same art or arguments were previously presented to the Office
- Should you wait until end of 9 months to challenge?
  - breadth of estoppel

# Post-Grant Review (PGR): Estoppel

---

- What: “any ground that the petition raised or reasonably could have raised during that post-grant review” arguing that the claim is invalid
- Where: before the USPTO, federal court, or the International Trade Commission
- Estoppel should properly be seen as having effect claim by claim, not by the patent as a whole

# Post-Grant Review (PGR): Litigation

---

- Barred if Petitioner also filed civil action challenging validity of the patent
- “Civil action” does not include counterclaim to infringement charge
- Subsequent litigation by Petitioner stayed
- If a patent infringement action is filed within three months of the patent grant, a court will not stay its consideration of a motion for preliminary injunction.

# Post-Grant Review (PGR): Reissued Patent

---

- A post-grant review may not be instituted or maintained if the petition requests cancellation of a claim identical or narrower in scope than a claim in the original patent, and more than nine months have passed since issuance of the original patent
- The provision regarding reissue patents with claims of identical or narrower scope acts to bar circumventing the nine month time limit for petitioning
  - What about an added claim element not properly provided for in the specification ?

# Settlement and Arbitration

---

- Provides for settlement by parties to a post-grant review proceeding, or for arbitration of any issue
  - *Shall* be terminated with respect to any petitioner upon the joint request of the petitioner and the patent owner, *unless* the Office has decided the merits of the proceeding before the request for termination is filed

# Transitional PGR for Certain Business-Method Patents

---

- “Covered Business-Method”—Method or apparatus for performing data processing operations in the financial industry
  - Exception: “technological inventions”
  - PTO to define “technological inventions”
- Sunsets after 8 years
  - Tracks PGR except:
    - Not limited to the 9 month deadline
    - Petitioner must be charged with or sued for infringement
- Provides same factors mentioned above for stay of litigation

# Post-Grant Review (PGR): Pros and Cons

---

- Advantages

- Broader grounds than reexamination or inter partes review
- Lower burden of proof than litigation
- Lower cost than litigation
- Final determination within 1-1½ years

- Disadvantages

- Requires quick and early action
- Must identify real parties in interest
- Estoppel effect



# Post Grant Review vs. EPO Opposition

---

- Post Grant Review
  - 9 months after issue
  - Any party except patentee
  - 101 statutory subject matter
  - 102 novelty
  - 103 obviousness
  - 112 (1) written description, enablement
  - 112(2) clarity

- Opposition
  - 9 months after grant
  - Any party except patentee
  - Arts. 52(2), 53, 57 excluded subject matter , industrial application
  - Arts. 52(1),54 Novelty
  - Arts. 52(1),56 Inventive Step
  - Arts. 83, 123(2) Sufficiency, added subject matter

# Post Grant Review vs. EPO Opposition

---

- Post Grant Review
  - Admissibility assessed more likely than not that at least 1 claim is unpatentable (high bar?)
  - Patentee *may* comment
  - Decision on admissibility *not* appealable
- Opposition
  - Admissibility assessed on formal grounds only, bar set low
  - Patentee *not involved* until admissibility accepted
  - Decision on admission *is* appealable

# Post Grant Review vs. EPO Opposition

---

- Post Grant Review
  - Written decision within 12 months of initiating proceedings
  - Ability to introduce new grounds or evidence unlikely
- Opposition
  - Oral Proceedings 18-30 months from end of opposition period, written decision +2-3 months
  - Allowability of new evidence based on relevance & amendments/arguments of other party

# Post-Grant Review (PGR): Phase In??

- Bill provides for the statutory authorization to limit the number of proceedings entertained in any one year for the first four years after implementation
- This graduated implementation would allow PTO to severely restrict number of PGRs





## Inter Partes Review (IPR)

# Inter Partes Review (IPR) – Introduction

---

- May be filed **after** the later of either:
  - 9 months after patent grant, or
  - If post-grant review is instituted, the date of its termination, or
  - Within 1 year of being sued
- Will eventually replace inter partes reexamination
- Effective Date: Same date and caveats as PGR
- Applies to patents issued before or after implementation

# Inter Partes Review (IPR): Basis

---

- Basis: **Patents and printed publications** like current Reexaminations
- Grounds: Novelty and Obviousness only
- Burden: Preponderance of the Evidence
- Threshold: **Reasonable likelihood that the Petitioner would prevail with respect to a claim** (similar to PGR and higher than SNQ threshold)

# Inter Partes Review (IPR): Timing

---

- Patent Owner may respond
- USPTO must initiate or not within 3 months
- Final determination within 1 year after initiation (extendable for 6 months by USPTO for good cause)



# IPR Similarities to PGR

---

- Petition requirements and preliminary response
  - Identify all real parties in interest
  - Identify challenged claims and grounds for challenge
  - Include declaration evidence, if any
  - Patentee has opportunity to argue against initiation
- Time allowed to PTO to initiate (3 months)
- Conduct of proceeding
- Ultimate burden of proof: Preponderance of the Evidence
- Opportunities for appeal from final decision for both parties and no appeal on whether to institute

# Inter Partes Review (IPR): Threshold

---

- Threshold PTO will use for determining whether inter partes review is appropriate:
  - There is a reasonable likelihood that the petitioner would prevail in showing invalidity with respect to at least one of the claims challenged in the petition
- Threshold:
  - Requires *similar* showing as the PGR threshold (i.e., “more likely than not”) and could require consideration of patentee rebuttal
  - Requires *more than* the current reexam threshold, i.e., substantial new question of patentability (SNQ)

# Inter Partes Review (IPR): Proceeding

---

- Like PGR
  - The Board will conduct each proceeding
    - May allow for limited discovery
    - Protective Orders
    - Oral hearing
  - Patentee may amend claims but cannot enlarge scope
  - Final determination within 1 year after initiation
    - For good cause, PTO may extend determination by 6 months
  - Either party may appeal to the Federal Circuit

# Inter Partes Review (IPR): Litigation

---

- Relationship to litigation very similar to PGR
  - Barred if Petitioner also filed civil action challenging validity of the patent
  - “Civil action” does not include counterclaim to infringement charge (accused infringer can file IPR)
- BUT, cannot file IPR more than 12 months after the petitioner is served with a complaint alleging infringement of patent
  - Must file within one year of being served

# Inter Partes Review (IPR): Estoppel

---

- What: “any ground that the petition raised or reasonably could have raised during that inter partes review” arguing that the claim is invalid
  - claim by claim estoppel
- Where: before the USPTO, federal court, or the International Trade Commission

# Inter Partes Review (IPR): Pros and Cons

---

## ■ Advantages

- Lower burden of proof than litigation
- Similar proof threshold as PGR
- Lower cost than litigation
- Not time limited, except if sued (one year)
- Final determination within 1-1½ years

## ■ Disadvantages

- Requires higher threshold than current reexamination procedures (SNQP)
- Fewer grounds than PGR (patents or publications only)
- Must identify real parties in interest
- Estoppel effect

# Comparison: Slide 1 of 3

	<b>Preissuance Submissions</b>	<b>Ex Parte Reexam</b>	<b>Inter Partes Reexam</b>	<b>Post-Grant Review</b>	<b>Inter Partes Review</b>
<b>When?</b>	Limited time before allowance	After grant	After grant (being replaced)	Within 9 months of grant	After 9 months of grant (or completion of PGR)
<b>Threshold showing</b>	N/A	SNQ	Reasonable likelihood of success (currently SNQ)	More likely than not or novel/unsettled legal question	Reasonable likelihood of success
<b>Anonymity</b>	Yes	Yes	No	No	No

# Comparison: Slide 2 of 3

	<b>Preissuance Submissions</b>	<b>Ex Parte Reexam</b>	<b>Inter Partes Reexam</b>	<b>Post-Grant Review</b>	<b>Inter Partes Review</b>
<b>Estoppel</b>	None	None	Issues raised or could have been raised	Issues raised or could have been raised	Issues raised or could have been raised
<b>Before Whom?</b>	Examiner	CRU	CRU	Board	Board
<b>Discovery/Evidence?</b>	N/A	Declaration	Declaration	Declaration and discovery	Declaration and discovery



# Comparison: Slide 3 of 3

	<b>Preissuance Submissions</b>	<b>Ex Parte Reexam</b>	<b>Inter Partes Reexam</b>	<b>Post-Grant Review</b>	<b>Inter Partes Review</b>
<b>Speed within PTO</b>	Case dependent	Many Years	Many Years	1 to 1½ years	1 to 1½ years
<b>Appeal</b>	Only patentee can appeal to Board and then Federal Circuit	Only patentee can appeal to Board and then Federal Circuit	Both parties can appeal to Board and then Federal Circuit	Both parties can appeal to Federal Circuit	Both parties can appeal to Federal Circuit

# Examples Looking Forward



Patent  
Attorney

Political  
Promise

# Scenario I: Application/Patent But No Suit

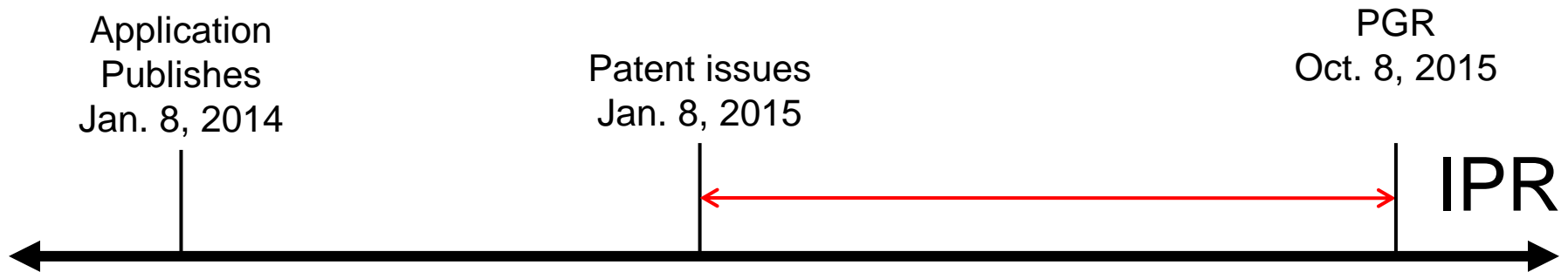

- Options for challenging the application/patent
  - Preissuance submission?
  - PGR? IPR?
  - Ex parte reexam?
- Strategy #1: Preissuance submission
- Strategy #2: PGR, or IPR if you are not able to seek PGR within the prescribed period (or want to limit estoppel to printed publication/patents)
- Strategy #3: Ex parte reexam, especially if no immediate threat of suit (avoids estoppel)

# Scenario II: Patent and Suit Ensues

Patent issues  
and A sues B  
Jan. 8, 2015

Deadline for PGR  
Oct. 8, 2015



- Options for challenging the patent
  - PGR? Ex parte reexam?
- Strategy #1:
  - File PGR ASAP (need to raise all issues that reasonably could be raised)
  - Request to stay litigation once PGR is instituted
- Strategy #2:
  - File ex parte reexam
  - Request to stay litigation once ex parte reexam is instituted
- Strategy #3:
  - File IPR after 9 months of issuance (limits estoppel)

# Scenario III: Sued on Patent Granted > 1 yr

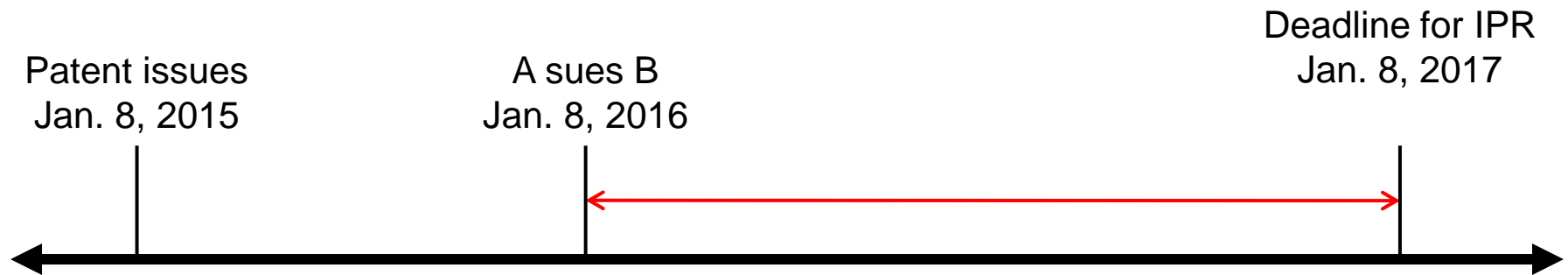

- Options for challenging the patent
  - IPR? Ex parte reexam?
- Strategy #1:
  - File IPR ASAP (need to raise all issues that could be raised related to patents or printed publication prior art)
  - Request to stay litigation once IPR is instituted
- Strategy #2: Ex parte reexam and raise best prior art in litigation (i.e., no IPR)

# Impact and Strategy Considerations

---

- Earlier opportunities to challenge applications or patents
- New and revised procedures that open “windows” for challenges
- Search early, search often

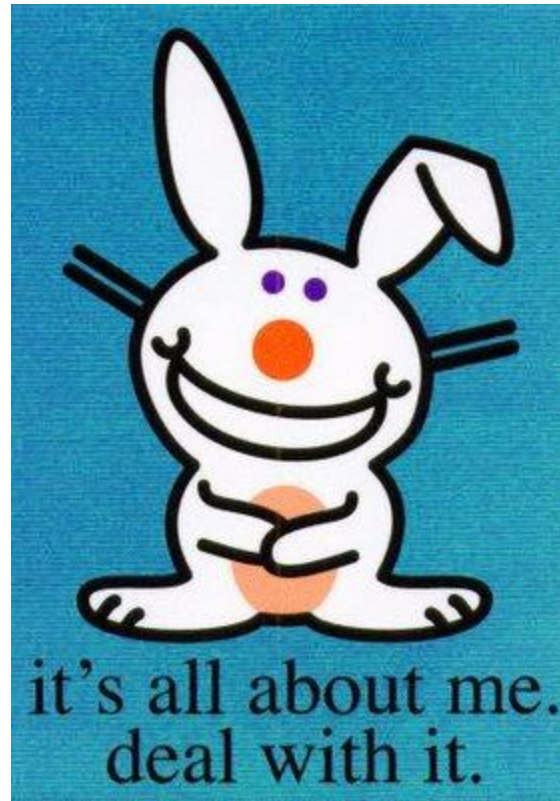

## Prior User Rights

# 35 U.S.C. § 273 – Key Provisions

---

- Requires a commercial use - **an internal commercial use** or an actual **arm's-length sale or other arm's-length commercial transfer of a useful end result**, whether or not the subject matter at issue is accessible to or otherwise known to the public ...
  - New act preserves in §§ 273(a)(1) and (c)(1)
- Nonprofit use covered, but only for continued use by and in the laboratory or nonprofit entity, not commercialization
  - New act substantively preserves in §§ 273 (c)(2).



# 35 U.S.C. § 273

---

- No longer limited to business methods
  - New act expands to a process, or a machine, manufacture, or composition of matter used in a manufacturing or other commercial process
- “effective filing date” of a patent is the earliest effective filing date
  - New act defines in § 100(i)
- Prior commercial use **at least 1 year before the effective filing date of such patent or public disclosure of the invention by the inventor.**
  - New act §273(a)(2) removes reference to prior user’s ARP

## 35 U.S.C. § 273(b)

---

- Sale by protected prior user exhausts patentee's rights
  - New act preserves in § 273(d)
- Defense not available if prior use derived from patentee
- Prior use defense is not a general license
  - Provisions preserved in §§ 273(e)(2) and (e)(3)

## 35 U.S.C. § 273(b)

---

- Burden of proof by prior user is **clear and convincing evidence**.
- Abandonment of use resets the clock.
  - New act preserves under §§ 273(b) and (c)(4)
- The defense may only be asserted by the person who performed the necessary acts and can only be transferred in the sale of an entire business
  - Preserved by new act as §273(e)(1)(A)

## 35 U.S.C. § 273(b)

---

- A defense acquired as part of a good faith assignment or transfer is limited to use in sites using the subject matter before such transfer
  - Preserved by new act as §273(e)(1)(A)
- Unsuccessful assertion of defense without a reasonable basis requires the court to **find the case exceptional**
- A patent shall not be deemed to be invalid under section 102 or 103 of this title solely because a defense is raised or established under this section. [No automatic prior art effect!]
  - Preserved by new act as §§ 273(f) and (g)

# Prior User Rights (35 U.S.C. § 273)

Current	NEW
Business Method claims § 273(b)(1)	Not limited to business methods § 273(a)
U.S. uses § 273(a)(1)	Same § 273(a)(1)
ARP 1 year prior to effective filing date § 273(b)(1)	ARP replaced with “commercially used” § 273(a)(1)
Commercial use prior to effective filing date § 273(b)(1)	Commercial use 1 year prior to effective filing date or public disclosure under 102(b) § 273(a)(2)
Available against patents developed by nonprofit universities	Not available against patents of nonprofit universities (except where RTP could not have involved Federal Funds) § 273(e)(5)(B)
Burden Clear & Convincing Evidence § 273(b)(3)(C)(4)	Same § 273(b)

# Joinder of Parties: New 35 U.S.C. § 299

---

- **Joinder or consolidated trial of accused infringers only if:**
  - Right to relief asserted against the parties jointly, severally, or in the alternative
  - Arising out of the same transaction, occurrence, or series of transactions or occurrences
  - Relating to the making, using, importing into the U.S., offering for sale, or selling of the same accused product or process; **and**
  - Questions of fact common to all accused infringers will arise
- **Allegations insufficient for joinder:** Accused infringers have infringed the same patent
- **Waiver:** Accused infringer may waive limitations as to itself

# Joinder of Parties: New 35 U.S.C. § 299

---

- Expected to reduce the number of Defendants named in large suits filed by non-practicing patent holders
- May result in more individual actions being filed by non-practicing patent holders, subject to cost limitations
- If multiple actions are filed in the same jurisdiction, the district court may consolidate them for discovery/claim construction in the interest of judicial economy



## Further Provisions



- The applicant for a patent in the U.S. is still required to disclose the Best Mode for practicing the invention
  - The PTO still has an obligation to only issue patents where the best mode requirement has been satisfied
- BUT failure to disclose the Best Mode is no longer a ground that can be relied upon in an invalidity or unenforceability attack
  - Could not be relied upon in litigations
  - Could not be relied upon in Post Grant Review proceedings
  - Not required for claim of domestic or foreign priority

- Why require disclosure of the best mode but limit the ability to enforce its presence – does the new law make sense?
  - Disclosure of the best mode allows the public to advance the technological arts by expanding on prior work – the *quid pro quo* of the patent system
  - Failing to disclose the best mode could serve to curtail innovation by others because best way to practice the invention would not be disclosed
  - But only limited number of cases have found invalidity based on best mode
  - New law theoretically reduces litigation/challenge costs by eliminating avenue of attack
- Effective Date: Immediately upon enactment

# Tax Strategy Inventions

- New law includes a specific section intended to prevent the issuance of patents directed to tax strategies
- For purposes of evaluating an invention under sections 102 or 103, any strategy for reducing, avoiding, or deferring tax liability, whether known or unknown at the time of the invention or application for patent, shall be deemed insufficient to differentiate claimed invention from the prior art
- Effective Date: Immediately upon enactment

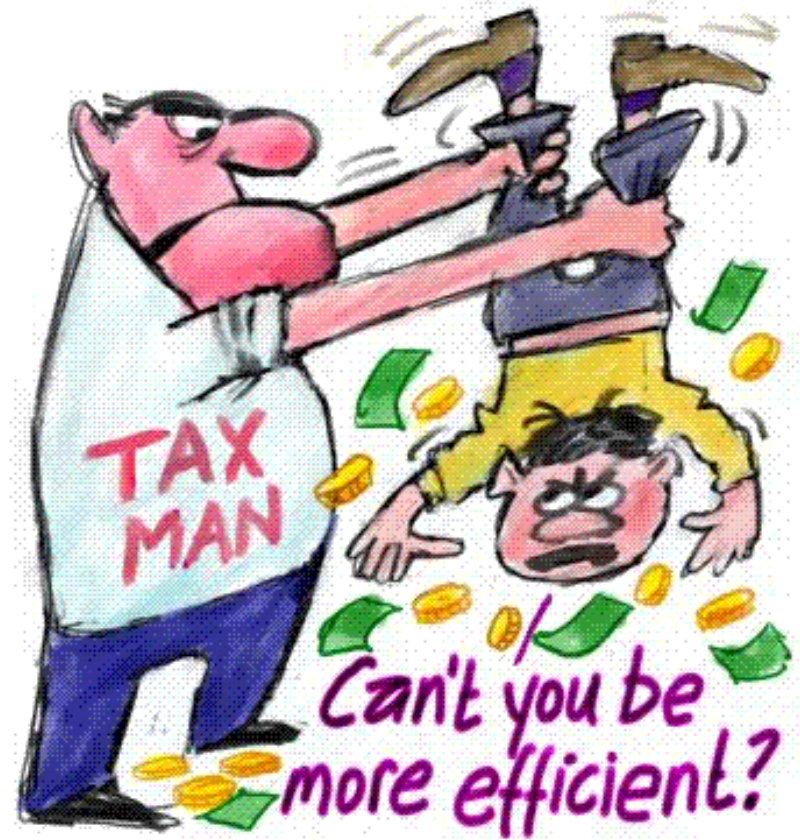

# Prioritized Examination

- Focuses on examination of inventions for “technologies important to American competitiveness”
  - Prioritized examination of applications for “products, processes, or technologies that are **important to the national economy** or national competitiveness”
  - Could become controversial if certain industries are promoted (wireless communication) while others are not (automobile industry)
- Effective Date: Ten days after enactment (calling all lobbyists!)



# Prioritized Examination

- Would have a substantial fee - \$4800 – in addition to regular filing fees
- To qualify, applications must contain no more than 4 independent claims or 30 total claims
- Number of applications requesting prioritized examination will be limited to no more than 10,000 per fiscal year (until regulations promulgated setting another limit)



# Micro Entity Status

---

- Micro entity is an entity that:
  - Qualifies as a small entity
  - Has not been named on 5 or more earlier filed applications
    - Excludes foreign and provisional applications
  - Did not in the prior calendar year have a gross income that exceeded 3 times most recent median household income
  - Is not contractually obliged to an entity having a gross income that exceeded 3 times most recent median household income
- Fees reduced by 75% for micro entities
- Effective Date: Immediately upon enactment

# False Marking Changes

---

- 35 U.S.C. § 292 permits "any person" to sue for a penalty of \$500 for every false marking offense
  - Any recovery **must be** equally split with the United States
- The lure of recovery of up to \$500 per each individual offense caused law firms to be established solely for the purpose of filing such false marking suits
- *Solo Cup* involved 20 billion paper cups, for a damages claim of \$10 Trillion (it didn't succeed!)
- Since January 2011, over 1450 false patent marking cases have been filed in the U.S.
  - See [www.falsemarking.net/district.php](http://www.falsemarking.net/district.php).

# False Marking Changes

---

- To greatly reduce the number of lawsuits, the new law eliminates false marking suits except when filed
  - By the United States or
  - Any person who has suffered competitive injury
- Applies to “all cases, without exception, pending on or after the date of enactment”
- 3-year safe harbor after a patent expires
- Effective Date: Immediately upon enactment



# Statutory Invention Registration

---

- Statutory Invention Registration (SIR) would be repealed under the new law
- As of enactment date, if you want to create prior art using the patent system, you will need to file a nonprovisional application and let it publish
- Cost would be higher than simply filing a SIR, but costs can be contained by abandoning the application after receipt of the first Office Action from the PTO
- Effective Date: 18 months after enactment

# PTO Fee Setting Authority

---

- 6 years
- Potential source of disagreement during reconciliation discussions
- May lead to significant fee increases
  - Increased use of fees to “manage” applicant behavior
    - Potentially increased RCE fee
    - Potentially increased claims fees (like EPO)
- Effective Date: Immediately upon enactment



# Patent Reform and Its Impact on Inequitable Conduct

# Inequitable Conduct

---

- Judicially created equitable remedy based on “unclean-hands” doctrine
- Finding of inequitable conduct with respect to one claim renders the entire patent unenforceable
- May taint enforceability of other U.S. patents
  - Patents in the same family
  - Patents issued with similar representations or omissions
- Currently, not curable by reexamination or reissue
  - But let’s see how AIA changes that

# Pre-*Therasense* Inequitable Conduct

---

- Defendant needs to prove by **clear and convincing evidence**:
  - Applicant made a misrepresentation or failed to disclose **material** information
  - With **intent** to deceive the PTO
- The district court then weighs the equities to determine whether the applicants' conduct warrants rendering the patent unenforceable

# Inequitable Conduct Pre-*Therasense*

---

- Prior decisions allowed:
  - Establishing materiality based on standards grounded in Rule 56 (“reasonable examiner” standard)
  - The “sliding scale” approach allowed the Court to accept less evidence of intent when materiality was high
  - An evolving standard for intent to deceive
    - 1988: *Kingsdown, en banc* CAFC rejects gross negligence standard
    - “knew or should have known materiality”
    - “single most reasonable inference”

# *Therasense*—Materiality

---

- Adopted “but-for” standard of materiality
  - Claim would not have issued “but-for” omission/misrepresentation of relevant information
  - Preponderance of evidence standard (before PTO)
  - Broadest reasonable construction of claim
  - Rejected current PTO’s Rule 56 for materiality
- EXCEPT where there was affirmative egregious misconduct (deemed *per se* material)
  - Filing a knowingly false declaration
  - Deliberately planned scheme to defraud

# *Therasense*—Egregious Misconduct

---

- Federal Circuit:
  - “When the patentee has engaged in **affirmative acts** of egregious misconduct, such as the filing of an unmistakably false affidavit, **the misconduct is material**. ...After all, a patentee is unlikely to go to great lengths to deceive the PTO with a falsehood unless it believes that the falsehood will affect issuance of the patent.”
  - “Because neither **mere nondisclosure of prior art references** to the PTO nor **failure to mention prior art references in an affidavit** constitutes affirmative egregious misconduct, claims of inequitable conduct that are based on such omissions require proof of but-for materiality.”



# *Therasense*—Specific Intent

---

- Accused infringer must prove that the patentee acted with **specific intent** to deceive the PTO
- Allegations of omission of information must show that the applicant made a **deliberate** decision to withhold information that he **knew to be material**
  - Gross negligence or negligence insufficient
  - No more sliding scale between intent and materiality

# *Therasense*—Specific Intent

---

- Intent may be inferred from indirect or circumstantial evidence
- The patentee does not need to provide an explanation until alleged infringer shows a threshold level of intent to deceive by clear and convincing evidence
  - But when inferring intent to deceive, that intent must be the single most reasonable inference from all of the evidence
  - Intent to deceive **cannot be found** where multiple reasonable inferences can be drawn

# PTO's Proposed Amendments to Rule 56

---

- Adopts the *Therasense* “but for plus” standard of materiality

“Section 1.56(b) as proposed to be amended would provide that information is **material to patentability** if it is material under the standard set forth in *Therasense*, and that information is material to patentability under *Therasense* if: (1) **The Office would not allow a claim if it were aware of the information**, applying the preponderance of the evidence standard and giving the claim its broadest reasonable construction; or (2) the **applicant engages in affirmative egregious misconduct** before the Office as to the information.”

# Impact of *Therasense* on Prosecution

---

- Categories of information
  - Prior art
  - Data
  - Related cases
  - Prior art from related cases
  - Office actions from related cases
  - Foreign prosecution (including translations of documents)
  - Inconsistent arguments
  - Related litigations

# Supplemental Examination

---

- Supplemental Examination and Amendment of Section 251 to Eliminate Intent to Deceive
  - Request examination of claims based on information that presents a substantial new question of patentability (SNQP) (reexam procedure)
  - Appears to establish “but-for” Materiality for both Supplemental Examination and Reissue
  - Does not expressly address intent to deceive
  - Allows submission of information in your own patents
    - Cannot submit art already raised in district court, ITC litigation, or Paragraph IV notices
- Effective Date: One year after enactment

# Supplemental Examination

---

- The legislation *may allow an applicant to purge its inequitable conduct*
- Language of the legislation: “*A patent shall not be held unenforceable* on the basis of conduct relating to information that had not been considered, was inadequately considered, or was incorrect *in a prior examination* of the patent *if the information was considered, reconsidered, or corrected during a supplemental examination* of the patent. The making of a request under subsection (a), or the absence thereof, shall not be relevant to enforceability of the patent under section 282.”

# Supplemental Examination

---

- Fraud exception

- *FRAUD.- If the Director becomes aware, during the course of a supplemental examination or reexamination proceeding ordered under this section, that a material fraud on the Office may have been committed in connection with the patent that is the subject of the supplemental examination, then in addition to any other action the Director is authorized to take, including the cancellation of any claims found to be invalid under section 307 as a result of a reexamination ordered under this section, the Director shall also refer the matter to the Attorney General for such further action as the Attorney General may deem appropriate.*

- What is “material fraud on the Office” and what investigation is needed?

# Supplemental Examination

---

- 3 months for PTO to indicate *whether or not* submitted information raises a SNQP
  - If no, patent cannot be held unenforceable on considered information (same results as “but for” materiality)
  - If yes, trigger examination
    - ***But*** patentee cannot make submissions regarding the art or claims before first Office Action



# Supplemental Examination

---

- Nothing in this section shall be construed—
  - (1) to preclude the imposition of sanctions based upon **criminal or antitrust laws** (including section 1001(a) of title 18, the first section of the Clayton Act, and section 5 of the Federal Trade Commission Act to the extent that section relates to unfair methods of competition);
  - (2) to limit the authority of the Director to investigate issues of possible **misconduct and impose sanctions** for misconduct in connection with matters or proceedings before the Office; or
  - (3) to limit the authority of the Director to **promulgate regulations** under chapter 3 relating to sanctions for misconduct by representatives practicing before the Office.

# Reissue Amendment

---

- Another purge opportunity?
- Amendment to reissue statute § 251, 253:
  - *Whenever any patent is, through error ~~without any deceptive intention~~, deemed wholly or partly inoperative or invalid, by reason of a defective specification or drawing, or by reason of the patentee claiming more or less than he had a right to claim in the patent, the Director shall, on the surrender of such patent and the payment of the fee required by law, reissue the patent*

# Comparison with Reissue and Reexam

---

## Supplemental Examination

- Supplemental Examination may be available to cure IC (subject to fraud exception)
- Information not limited to patents or printed publications
- Issues brought before PTO cannot be used in IC defense
- No IC even if claims require amendment in view of new information

## Reissue & Reexam

- Reissue and Reexam cannot cure Inequitable Conduct
- Reexamination limited to patents or printed publications
- Reissue requires identification of “error” made without deceptive intent, which results in patent being “wholly or partly inoperative or invalid” (but see amendment)
- Due to “but for” test, no IC if claims are allowed *unamended* in view of new information, otherwise references available for IC
- Even if successful, references can still be used in an Inequitable Conduct defense



# Recent U.S. Supreme Court Patent Law Decisions

# Global-Tech v. SEB

---

- *Global-Tech Appliances, Inc. v. SEB S.A.*, 131 S. Ct. 458 (2010)
- The issue in *Global-Tech* was whether a party who "actively induces infringement of a patent" under 35 U.S.C. § 271(b) must know that the induced acts constitute patent infringement



# Global-Tech v. SEB

- 1999 - French small-appliance manufacturer SEB sued defendants Montgomery Ward & Co., Inc., Global-Tech Appliances, Inc., and Pentalpha Enterprises, Ltd. (collectively “Pentalpha”) for infringement of their U.S. Patent No. 4,995,312 (“the ‘312 patent”)

## United States Patent [19]

### Leiros

[54] COOKING APPLIANCE WITH ELECTRIC HEATING  
 [75] Inventor: Ernest Leiros, Dijon, France  
 [73] Assignee: SEB S.A., Selongey, France  
 [21] Appl. No.: 574,529  
 [22] Filed: Aug. 28, 1990

### Related U.S. Application Data

[63] Continuation of Ser. No. 488,504, Mar. 5, 1990, abandoned, which is a continuation of Ser. No. 191,864, May 9, 1988, abandoned.

### Foreign Application Priority Data

May 13, 1987 [FR] France .....

[51] Int. Cl.<sup>5</sup> .....

[52] U.S. Cl. .....

[58] Field of Search .....

[56] References Cited

### U.S. PATENT DOCUMENTS

2,219,849 10/1940 Childs ..... 99/403 X  
 2,997,695 5/1952 Braski et al. .... 99/411 X  
 2,755,436 7/1956 Schweske ..... 99/403 X  
 2,863,037 12/1958 Johnstone ..  
 3,435,150 3/1969 Pries ..... 99/403  
 3,463,077 8/1969 Lescaire ..... 99/403  
 3,377,908 5/1971 Burg ..... 99/313  
 3,725,841 4/1973 Tip ..... 219/433  
 3,746,877 7/1973 Frey et al. .... 219/387

[11] Patent Number: 4,995,312

[45] Date of Patent: Feb. 26, 1991

3,801,331 4/1974 Sato et al. .... 99/403  
 4,011,421 3/1977 Levin ..... 99/342 X  
 4,138,606 2/1979 Brown ..... 219/402  
 4,148,250 4/1979 Miki et al. .... 99/403  
 4,181,993 2/1980 Kaufman ..... 99/403  
 4,487,117 12/1984 Colley et al. .... 99/403 X  
 4,560,850 12/1985 Levedansky et al. ... 99/DIG. 14 X  
 4,622,230 11/1986 Stone, Jr. .... 99/295 X  
 4,672,179 6/1987 Oishi et al. .... 99/403 X  
 4,728,778 3/1988 Chert et al. .... 126/381

### FOREIGN PATENT DOCUMENTS

2046681 3/1971 France ..  
 2120637 8/1972 France ..  
 290283 11/1985 Spain ..

Primary Examiner—Timothy F. Simone  
 Attorney, Agent, or Firm—Young & Thompson

### ABSTRACT

A plastic skirt (3) surrounding a metal pan (1) is employed for external heat-insulation of electrically-heated cooking appliances and in particular deep fryers. The skirt (3) is of plastic material which does not continuously withstand the temperature of the pan wall (1a, 1b) and is separated from this wall by an air space (4) of sufficient width to limit the temperature of the skirt (3). The skirt is completely free with respect to the pan (1) with the exception of a ring (5) which joins the top edge (3a) of the skirt to the top edge (1c) of the pan and to which this latter is attached. The ring (5) is of heat-insulating material which affords continuous resistance to the temperature of the top edge (1c) of the pan (1).

13 Claims, 2 Drawing Sheets

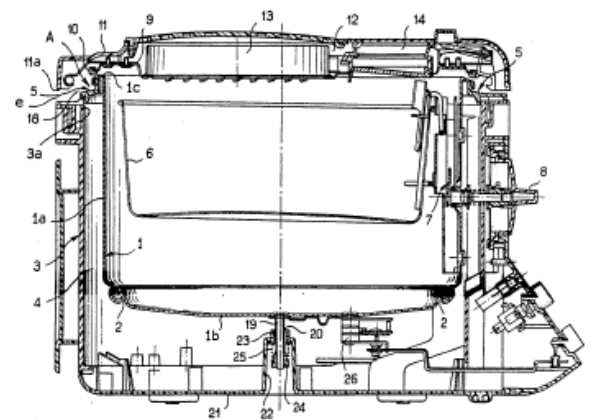

# Global-Tech v. SEB

---

- The '312 patent directed to an electrical deep fryer
  - includes an air space between the heating pan and an outer plastic housing
  - The air gap prevents heat transfer so that the outside of the fryer remains relatively cool
- Based on this “cool-touch” feature, SEB’s fryers were considered superior

# Global-Tech v. SEB

---

- In 1997, Sunbeam asked Pentalpha to supply fryers with certain specifications
  - Pentalpha bought an SEB fryer in Hong Kong and copied all but the cosmetic features
  - the SEB fryer on the Hong Kong market was not marked with the U.S. '312 patent

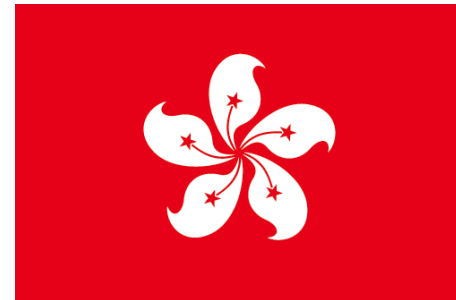



# Global-Tech v. SEB

---

- Pentalpha hired a U.S. Patent Attorney to conduct a right-to-use investigation
  - did not inform the attorney that they had copied the design
  - the attorney failed to discover the '312 patent during his investigation
  - the attorney provided a freedom-to-operate opinion



# Global-Tech v. SEB

---

- In 1998, after SEB's customers began buying fryers from Sunbeam, SEB sued Sunbeam for infringement of the '312 patent.
  - Sunbeam informed Pentalpha of the litigation
  - Sunbeam settled with SEB
  - Pentalpha continued selling the copied fryer to others
- In 1999, SEB sued Pentalpha
  - jury found willful, direct and induced infringement
  - SEB awarded \$4.8 million.

# Global-Tech v. SEB

---

- Pentalpha appealed:
  - argued there was no direct evidence that they had actual knowledge of SEB’s patent before suit
  - the Federal Circuit affirmed
    - Pentalpha “deliberately disregarded a known risk” that SEB had a patent on the fryer that it copied
    - court held direct evidence of actual knowledge of a patent is not required for induced infringement
    - *SEB S.A. v. Montgomery Ward & Co., Inc.*, 594 F.3d 1360 (Fed. Cir. 2010). The Supreme Court granted *cert.*, 131 S. Ct. 2060 (May 31, 2011).

# Global-Tech v. SEB

---

- Supreme Court ruled that it is not enough to show that the accused knew that certain acts would occur
  - the accused must have known that there was a patent and that the acts infringed that patent
- The Court rejected the Federal Circuit’s “deliberate indifference of a known risk” standard
- Nonetheless, the Court affirmed the Federal Circuit’s finding of infringement based on the doctrine of “willful blindness.”

# Global-Tech v. SEB

---

- Willful blindness
  - well-established principle in criminal law
  - defendants cannot escape liability by deliberately shielding themselves from clear evidence of critical facts that are strongly suggested by the circumstances
  - long history and acceptance of this doctrine, the Court found no reason why willful blindness should not also apply in civil suits

# Global-Tech v. SEB

---

- The Court held that a defendant engages in such conduct when the defendant:
  - subjectively believes that there is a high probability that a fact exists; and
  - takes deliberate actions to avoid learning of those facts
- Compared with the “deliberately disregarded a known risk” standard:
  - Federal Circuit’s test would permit a finding of knowledge when there was merely a known risk that the acts were infringing (no need for any active efforts by the defendant to avoid knowing about the infringing nature of the activities)

# Global-Tech v. SEB

---

- The Supreme Court affirmed:
  - Pentalpha knew that SEB's fryer had a substantial share of the market compared with other fryers
  - Pentalpha chose to copy an overseas model of the SEB fryer knowing that these usually do not bear the U.S. patent markings
  - Pentalpha obtained a freedom-to-operate opinion without informing the attorney that it had reverse engineered SEB's fryer
    - no evidence to explain why Pentalpha failed to disclose that copying to the attorney

# Microsoft v. i4i

- *Microsoft Corp. v. i4i Limited Partnership et al.*, No. 10-290 (June 9, 2011).
- Issue: what burden of proof a defendant carries when asserting a defense of invalidity to an allegation of infringement
  - U.S. Patents are entitled to a presumption of validity under 35 U.S.C. § 282
  - since 1984 has been interpreted by the Federal Circuit as requiring “clear and convincing” evidence
    - Proof which is more than a mere preponderance of the evidence, but less than proof “beyond a reasonable doubt.” The clear and convincing standard is met where the truth of the facts asserted is highly probable. See e.g., BLACK’S LAW DICTIONARY 251 (6<sup>th</sup> ed. 1990).



# Microsoft v. i4i

---

- March 2007: i4i sued Microsoft in the U.S. District Court for the Eastern District of Texas for infringing its U.S. Patent No. 5,787,449 (“the ’449 patent”)
  - certain versions of Microsoft Word alleged to infringe
  - the ’449 patent claims a method for storing and processing electronic document data allegedly practiced by Microsoft Word’s XML editor

# Microsoft v. i4i

---

- Microsoft alleged invalidity of the i4i patent because of an on-sale bar:
  - certain i4i software (“S4”), sold more than one year prior to the filing date of the ’449 patent, alleged to contained the claimed invention
  - i4i did not cite S4 to the PTO during prosecution of the ’449 patent, because the source code had been destroyed years earlier
  - the programmers who developed S4 were the same as the inventors of the ’449 patent, and they testified that S4 was different

# Microsoft v. i4i

---

- Microsoft proposed jury instructions:
  - apply lower “preponderance of the evidence” standard for question of whether S4 invalidated the '449 patent under an on-sale bar
- The District Court did not adopt Microsoft’s proposed hybrid standard in its jury instructions
- The jury found the i4i patent not invalid and infringed
  - \$290 million judgment against Microsoft
  - 670 F. Supp. 2d 568 (E.D. Tex. Aug. 11, 2009)

# Microsoft v. i4i

---

- Microsoft appealed:
  - argued the district court erred by applying the clear and convincing evidence standard
  - the USPTO never considered the S4 evidence during prosecution
- The Federal Circuit disagreed with Microsoft and affirmed the judgment of the district court. 598 F.3d 831 (2010)

# Microsoft v. i4i

---

- Microsoft petitioned for certiorari to the Supreme Court
- On June 9, 2011, in an 8-0 decision (Justice Roberts recused himself), the Court held:
  - the Patent Act requires invalidity to be proven by clear and convincing evidence, and not a preponderance of the evidence
  - even in situations where newly-submitted evidence not before the USPTO during prosecution is placed into evidence

# Microsoft v. i4i

---

- The Court reasoned:
  - § 282 of the Patent Act of 1952 says a patent is “presumed valid,” and the presumption of validity had a “settled meaning” in the common law
  - case law before the enactment of the Patent Act held that “a defendant raising an invalidity defense bore ‘a heavy burden of persuasion,’ requiring proof of the defense by clear and convincing evidence”
  - in passing the 1952 Act, Congress codified the settled meaning of the common law presumption, notwithstanding the absence of the words “clear and convincing” in the statute

# Microsoft v. i4i

---

- The Court also rejected Microsoft's argument that a lower evidentiary standard should apply where the USPTO had not considered newly-presented evidence in deciding to grant the patent
  - The Court could find nothing in its precedents to justify a departure from the clear and convincing standard
  - but did state that a finder of fact could weigh the fact that the USPTO had not considered evidence of invalidity into their determination of whether the clear and convincing standard had been met

# Speaker Biographies



**Eric P. Raciti** (*eric.raciti@finnegan.com/+32 2 646 70 25*)

- Practice focuses on working with clients to develop comprehensive and sophisticated patent strategies, including strategic patent procurement and portfolio development and competitive intelligence and analysis.
- Experience in agreement drafting and corporate transactions involving intellectual property, as well as patent prosecution and strategic IP counseling.
- Former patent examiner in the surgical arts and attorney in the Office of Legislative and International Affairs.



**Anthony C. Tridico, Ph.D.** (*anthony.tridico@finnegan.com/+32 2 643 70 20*)

- Managing Partner of the firm's European office in Brussels, Belgium.
- Experience in all aspects of patent law including prosecution, opinion preparation, due diligence investigations, interferences and litigation.
- Practice focuses on client counseling, IP portfolio management and patent prosecution (appeals, reissue, reexam) in the chemical (organic, polymer), pharmaceutical, and biotechnological arts.
- Frequent lecturer on various aspects of on patent law issues affecting the chemical, pharmaceutical, and biotech industries.



---

**Thank you!**